

## Thyristors

### SKT 1800 SKT 2400



#### Features

- Hermetic metal cases with ceramic insulators
- Amplifying gates
- Capsule packages for double sided cooling
- Shallow design with single sided cooling
- Off-state and reverse voltages up to 1800 V

#### Typical Applications

- DC motor control (e. g. for machine tools)
- Controlled rectifiers (e. g. for battery charging)
- AC controllers (e. g. for temperature control)
- Soft starters for AC motors

V <sub>RSM</sub>	V <sub>RRM</sub> V <sub>DRM</sub>	$\left(\frac{dv}{dt}\right)_{cr}$	I <sub>T(RMS)</sub> (maximum values for continuous operation)	
			4500 A	5700 A
V	V	V/μs	I <sub>TAV</sub> (sin. 180; T <sub>case</sub> = . . . ; DSC)	
			2500 A (60 °C)	3000 A (56 °C)
1300	1200	1000	<b>SKT 1800/12 E</b>	<b>SKT 2400/12 E</b>
1500	1400	1000	<b>SKT 1800/14 E</b>	<b>SKT 2400/14 E</b>
1700	1600	1000	<b>SKT 1800/16 E</b>	<b>SKT 2400/16 E</b>
1900	1800	1000	-	<b>SKT 2400/18 E</b>

Symbol	Conditions	SKT 1800	SKT 2400
I <sub>TAV</sub>	sin. 180; (T <sub>case</sub> = ...); DSC	1800 A (85 °C)	2400 A (75 °C)
I <sub>TSM</sub>	T <sub>vj</sub> = 25 °C T <sub>vj</sub> = 125 °C	53 000 A 45 000 A	55 000 A 47 000 A
i <sup>2</sup> <sub>t</sub>	T <sub>vj</sub> = 25 °C T <sub>vj</sub> = 125 °C	14 000 000 A <sup>2</sup> s 10 000 000 A <sup>2</sup> s	15 125 000 A <sup>2</sup> s 11 000 000 A <sup>2</sup> s
t <sub>gd</sub>	T <sub>vj</sub> = 25 °C; I <sub>G</sub> = 1 A; di <sub>G</sub> /dt = 1 A/μs	typ. 1 μs	
t <sub>gr</sub>	V <sub>D</sub> = 0,67 · V <sub>DRM</sub>	typ. 2 μs	
(di/dt) <sub>cr</sub>	f = 50 . . . 60 Hz	150 A/μs	
I <sub>H</sub>	T <sub>vj</sub> = 25 °C; typ./max.	500 mA/1 A	
I <sub>L</sub>	T <sub>vj</sub> = 25 °C; typ./max.	2 A/5 A	
t <sub>q</sub>	T <sub>vj</sub> = 125 °C; typ.	200 ... 300 μs	
V <sub>T</sub>	T <sub>vj</sub> = 25 °C; I <sub>T</sub> = 3000 A; max.	1,25 V	1,37 V
V <sub>T(TO)</sub>	T <sub>vj</sub> = 125 °C	0,88 V	0,88 V
r <sub>T</sub>	T <sub>vj</sub> = 125 °C	0,124 mΩ	0,164 mΩ
I <sub>DD</sub> , I <sub>RD</sub>	T <sub>vj</sub> = 125 °C; V <sub>DD</sub> = V <sub>DRM</sub> ; V <sub>RD</sub> = V <sub>RRM</sub>	100 mA	100 mA
V <sub>GT</sub>	T <sub>vj</sub> = 25 °C	3 V	
I <sub>GT</sub>	T <sub>vj</sub> = 25 °C	300 mA	
V <sub>GD</sub>	T <sub>vj</sub> = 125 °C	0,25 V	
I <sub>GD</sub>	T <sub>vj</sub> = 125 °C	10 mA	
R <sub>thjc</sub>	cont. DSC	0,015	0,0105
R <sub>thch</sub>	sin. 180; DSC/SSC } °C/W rec. 120; DSC/SSC	0,0155/0,0330	0,0110/0,0240
		0,0165/0,0345	0,0118/0,0250
T <sub>vj</sub>	DCS/SSC	0,003/0,006	0,002/0,004
T <sub>stg</sub>		- 40 ... +125 °C - 40 ... +130 °C	
F	SI units	27 ... 34 kN	37 ... 47 kN
w	US units	6000 ... 7600 lbs.	8000 ... 10000 lbs.
		1 kg	1,7 kg
Case		B 19	B 20

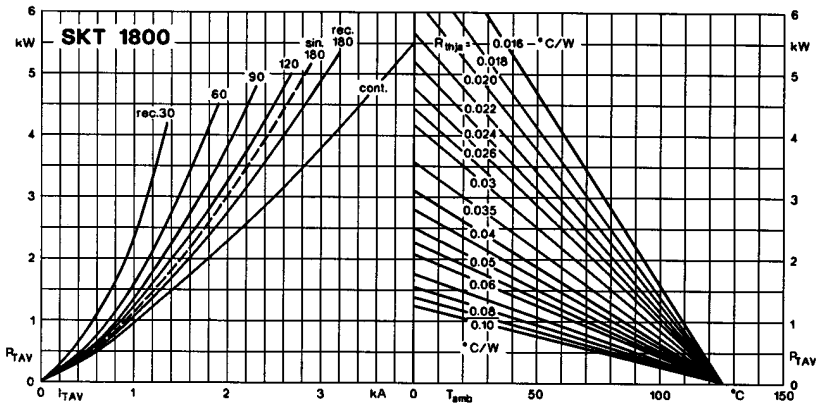

Fig. 1 a Power dissipation vs. on-state current and ambient temperature

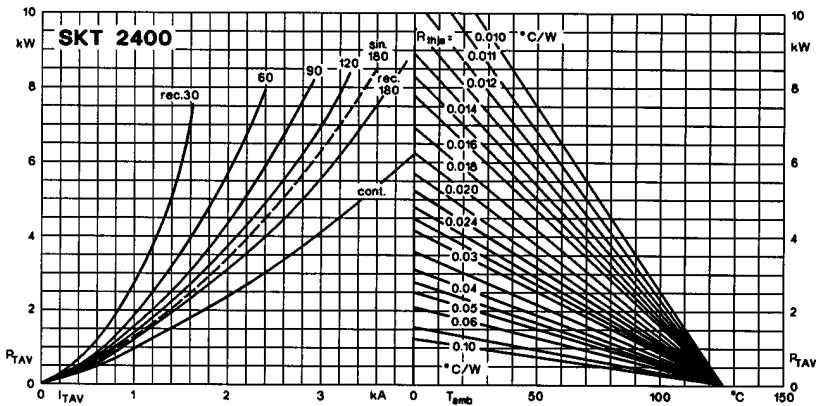

Fig. 1 b Power dissipation vs. on-state current and ambient temperature

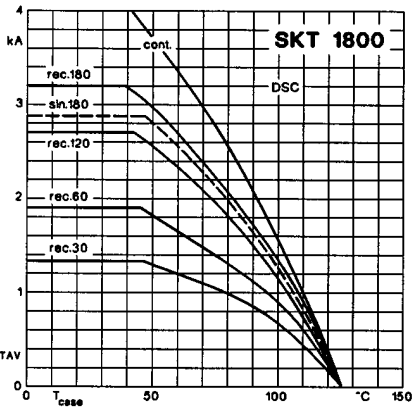

Fig. 2 a Rated on-state current vs. case temperature

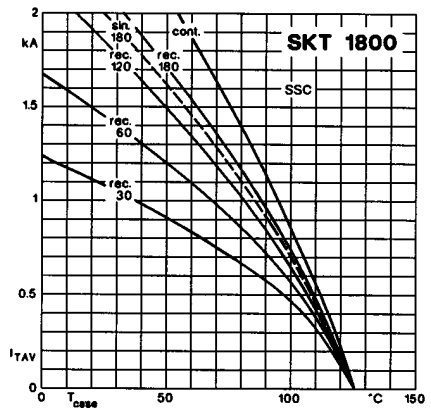

Fig. 2 b Rated on-state current vs. case temperature

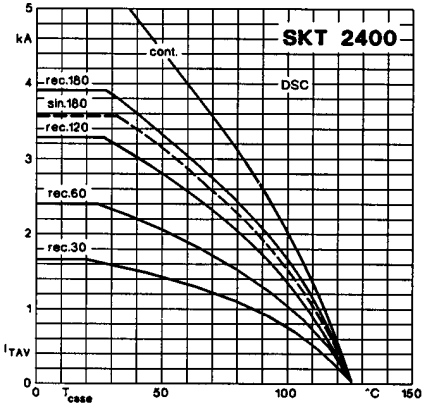

Fig. 2 c Rated on-state current vs. case temperature

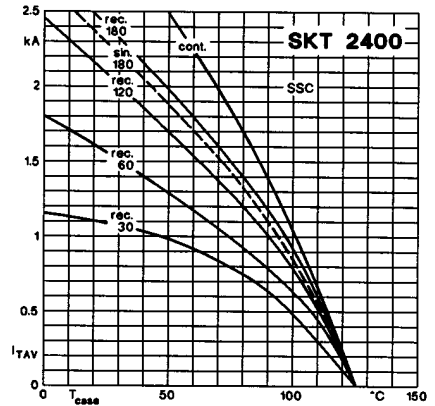

Fig. 2 d Rated on-state current vs. case temperature

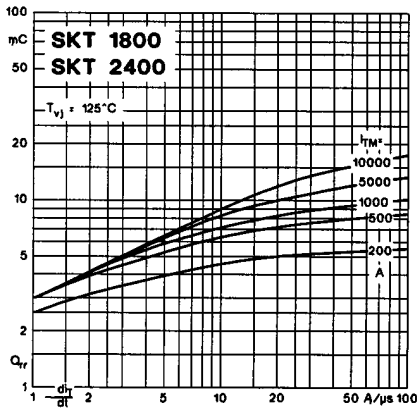

Fig. 3 Recovered charge vs. current decrease

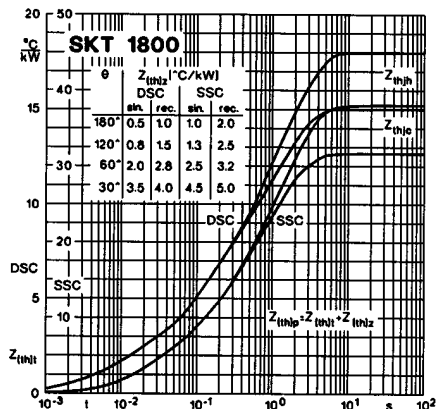

Fig. 4 a Transient thermal impedance vs. time

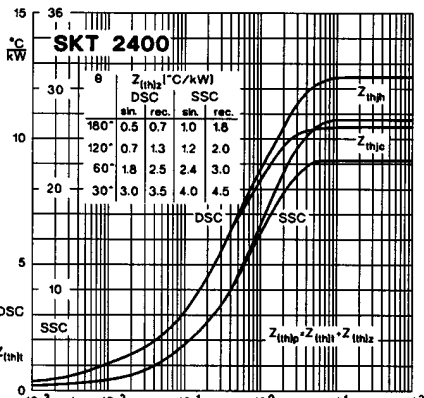

Fig. 4 b Transient thermal impedance vs. time

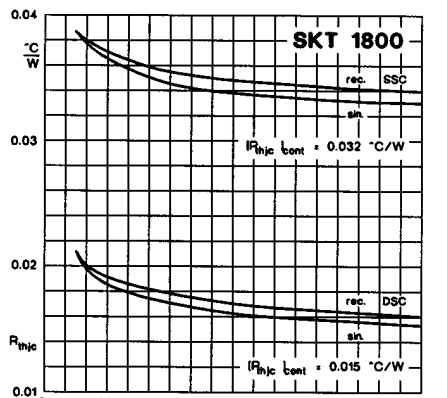

Fig. 5 a Thermal resistance vs. conduction angle

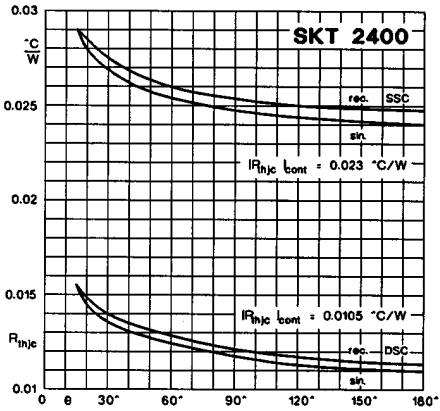

Fig. 5 b Thermal resistance vs. conduction angle

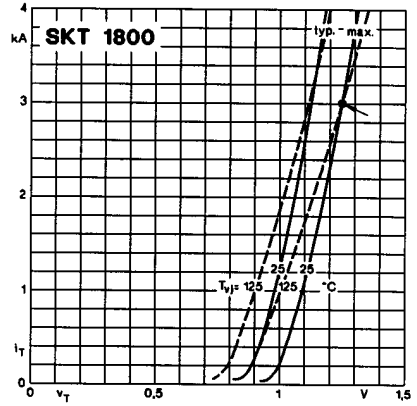

Fig. 6 a On-state characteristics

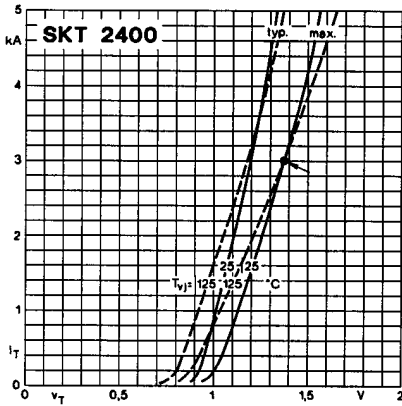

Fig. 6 b On-state characteristics

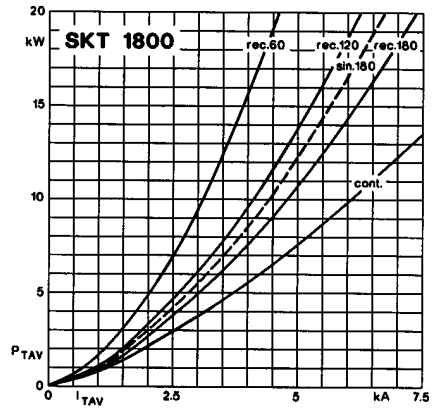

Fig. 7 a Power dissipation vs. on-state current

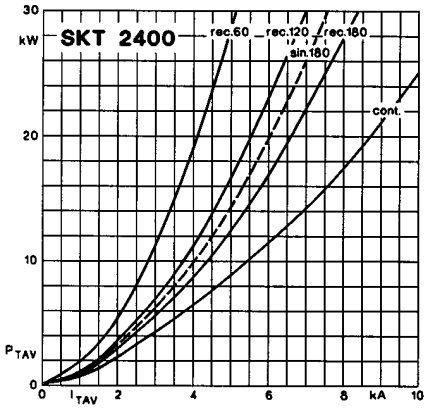

Fig. 7 b Power dissipation vs. on-state current

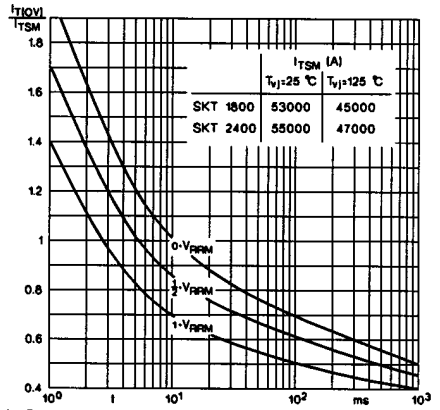

Fig. 8 Surge overload current vs. time

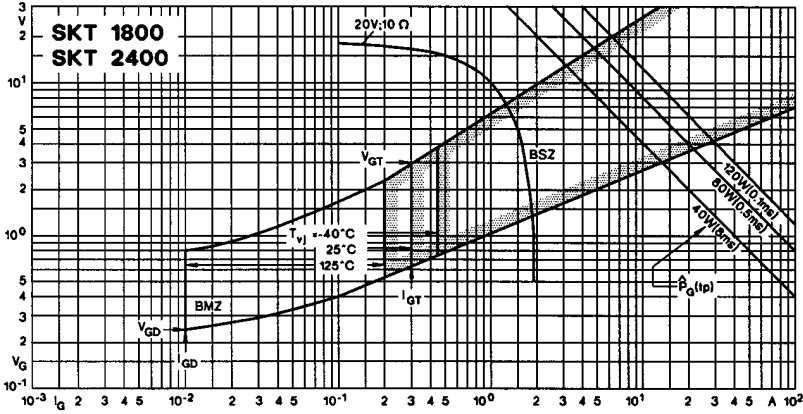
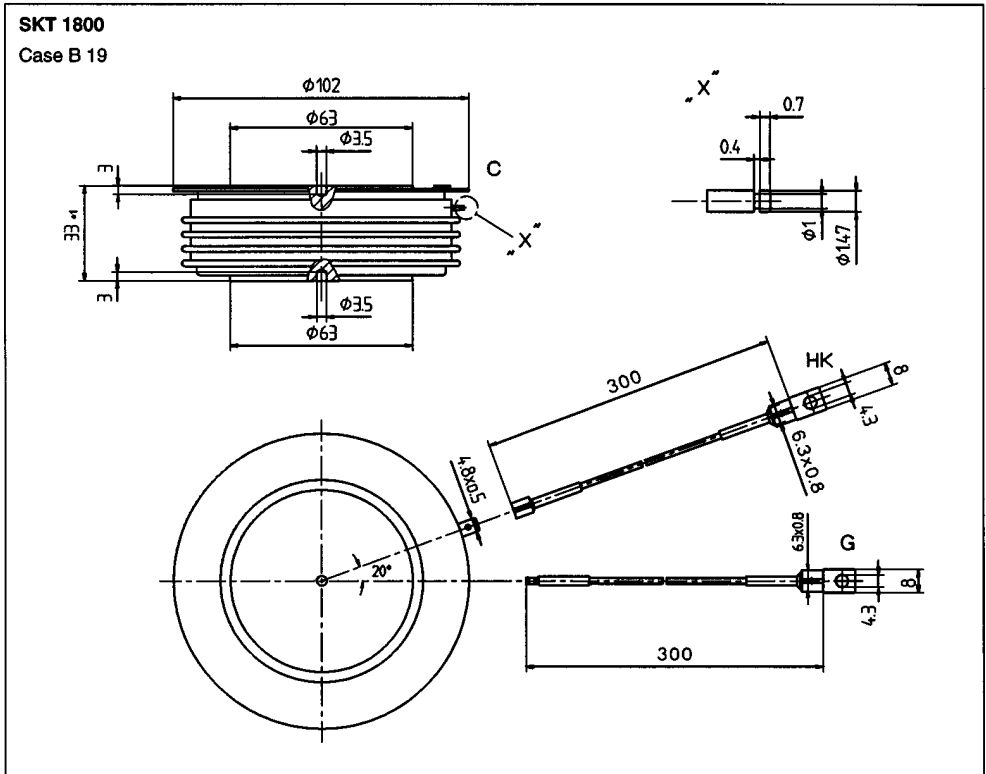

Fig. 9 Gate trigger characteristics



- C: Cathode terminal
- A: Anode terminal
- G: Gate terminal (yellow sleeve)
- HK: Auxiliary cathode terminal (red sleeve)

Dimensions in mm

**SKT 2400**

Case B 20

JEDEC: TO-200 AF

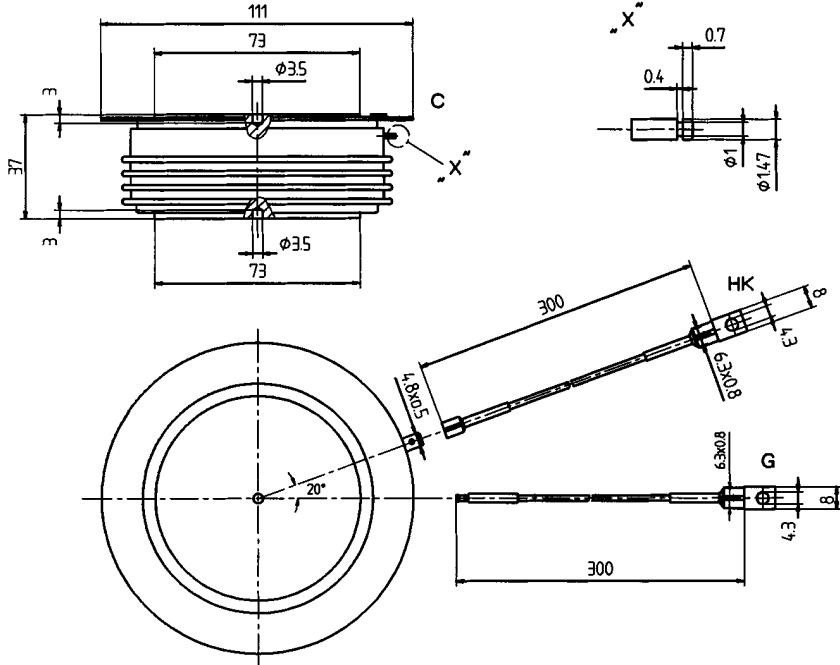

- C: Cathode terminal
- A: Anode terminal
- G: Gate terminal (yellow sleeve)
- HK: Auxiliary cathode terminal (red sleeve)

Dimensions in mm