

TOSHIBA PHOTOCOUPLER GaAs IRED & PHOTO-TRIAC

TLP3041, TLP3042, TLP3043

Unit in mm

OFFICE MACHINE

HOUSEHOLD USE EQUIPMENT

TRIAC DRIVER

SOLID STATE RELAY

The TOSHIBA TLP3041, TLP3042 and TLP3043 consist of a zero voltage crossing turn-on photo-triac optically coupled to a gallium arsenide infrared emitting diode in a six lead plastic DIP package.

- Peak Off-State Voltage : 400V (Min.)
- Trigger LED Current : 15mA (Max.) (TLP3041)
10mA (Max.) (TLP3042)
5mA (Max.) (TLP3043)
- On-State Current : 100mA (Max.)
- UL Recognized : UL1577, File No. E67349
Isolation Voltage : 5000Vrms (Min.)
- Option (D4) type VDE Approved : DIN VDE0884 / 08.87,
Certificate No. 68329

Maximum Operating Insulation Voltage : 630V_{PK}

Highest Permissible Over Voltage : 6000V_{PK}

(Note) When a VDE0884 approved type is needed, please designate the "Option (D4)"

- | | | |
|------------------------|----------------------|---------------------|
| | <u>7.62mm pich</u> | <u>10.16mm pich</u> |
| | <u>standard type</u> | <u>(LF2) type</u> |
| ● Creepage Distance : | 7.0mm (Min.) | 8.0mm (Min.) |
| Clearance : | 7.0mm (Min.) | 8.0mm (Min.) |
| Insulation Thickness : | 0.5mm (Min.) | 0.5mm (Min.) |

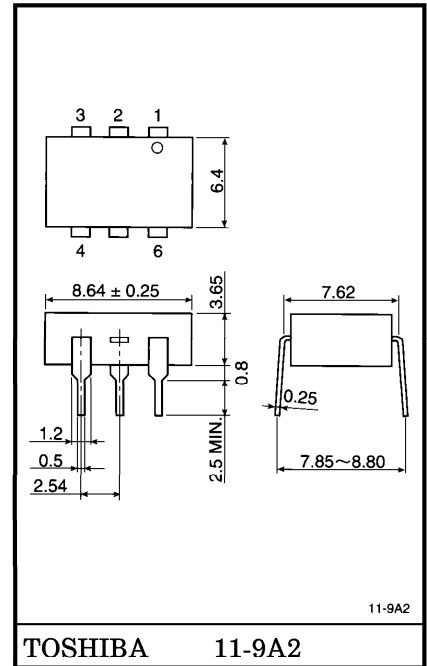

TOSHIBA 11-9A2

Weight : 0.44g

PIN CONFIGURATION (TOP VIEW)

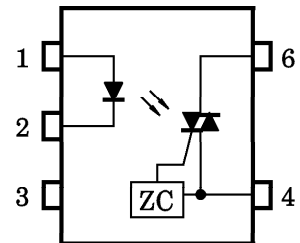

- 1 : ANODE
- 2 : CATHODE
- 3 : NC
- 4 : TERMINAL 1
- 6 : TERMINAL 2

MAXIMUM RATINGS (Ta = 25°C)

CHARACTERISTIC		SYMBOL	RATING	UNIT
LED	Forward Current	I _F	50	mA
	Forward Current Derating (Ta ≥ 53°C)	ΔI _F / °C	-0.7	mA / °C
	Peak Forward Current (100μs pulse, 100pps)	I _{FP}	1	A
	Power Dissipation	P _D	100	mW
	Power Dissipation Derating (Ta ≥ 25°C)	ΔP _D / °C	-1.0	mW / °C
	Reverse Voltage	V _R	5	V
	Junction Temperature	T _j	125	°C
DETECTOR	Off-State Output Terminal Voltage	V _{DRM}	400	V
	On-State RMS Current	Ta = 25°C	100	mA
		Ta = 70°C	50	
	On-State Current Derating (Ta ≥ 25°C)	ΔI _T / °C	-1.1	mA / °C
	Peak On-State Current (100μs pulse, 120pps)	I _{TP}	2	A
	Peak Nonrepetitive Surge Current (P _w = 10ms, DC = 10%)	I _{TSM}	1.2	A
	Power Dissipation	P _D	300	mW
	Power Dissipation Derating (Ta ≥ 25°C)	ΔP _D / °C	-4.0	mW / °C
	Junction Temperature	T _j	115	°C
Storage Temperature Range	T _{stg}	-55~150	°C	
Operating Temperature Range	T _{opr}	-40~100	°C	
Lead Soldering Temperature (10s)	T _{sol}	260	°C	
Total Package Power Dissipation	P _T	330	mW	
Total Package Power Dissipation Derating (Ta ≥ 25°C)	ΔP _T / °C	-4.4	mW / °C	
Isolation Voltage (AC, 1 min., R.H. ≤ 60%) (Note 1)	BV _S	5000	V _{rms}	

(Note 1) Device considered a two terminal device : Pins 1, 2 and 3 shorted together and pins 4 and 6 shorted together.

RECOMMENDED OPERATING CONDITIONS

CHARACTERISTIC	SYMBOL	MIN.	TYP.	MAX.	UNIT
Supply Voltage	V _{AC}	—	—	120	V _{ac}
Forward Current	I _F *	15	20	25	mA
Peak On-State Current	I _{TP}	—	—	1	A
Operating Temperature	T _{opr}	-25	—	85	°C

※ In the case of TLP3042

INDIVIDUAL ELECTRICAL CHARACTERISTICS (Ta = 25°C)

CHARACTERISTIC		SYMBOL	TEST CONDITION	MIN.	TYP.	MAX.	UNIT
LED	Forward Voltage	V_F	$I_F = 10\text{mA}$	1.0	1.15	1.3	V
	Reverse Current	I_R	$V_R = 5\text{V}$	—	—	10	μA
	Capacitance	C_T	$V = 0, f = 1\text{MHz}$	—	10	—	pF
DETECTOR	Peak Off-State Current	I_{DRM}	$V_{DRM} = 400\text{V}$	—	10	100	nA
	Peak On-State Voltage	V_{TM}	$I_{TM} = 100\text{mA}$	—	1.7	3.0	V
	Holding Current	I_H	—	—	0.6	—	mA
	Critical Rate of Rise of Off-State Voltage	dv/dt	$V_{in} = 120\text{Vrms}, T_a = 85^\circ\text{C}$ (Fig.1)	200	500	—	$\text{V}/\mu\text{s}$
	Critical Rate of Rise of Commutating Voltage	$dv/dt(c)$	$V_{in} = 30\text{Vrms}, I_T = 15\text{mA}$ (Fig.1)	—	0.2	—	$\text{V}/\mu\text{s}$

COUPLED ELECTRICAL CHARACTERISTICS (Ta = 25°C)

CHARACTERISTIC		SYMBOL	TEST CONDITION	MIN.	TYP.	MAX.	UNIT
Trigger LED Current	TLP3041	I_{FT}	$V_T = 3\text{V}$	—	—	15	mA
	TLP3042			—	5	10	
	TLP3043			—	—	5	
Inhibit Voltage	V_{IH}	$I_F = \text{Rated } I_{FT}$	—	—	40	V	
Leakage in Inhibited State	I_{IH}	$I_F = \text{Rated } I_{FT}$ $V_T = \text{Rated } V_{DRM}$	—	100	300	μA	
Capacitance Input to Output	C_S	$V_S = 0, f = 1\text{MHz}$	—	0.8	—	pF	
Isolation Resistance	R_S	$V_S = 500\text{V (R.H.} \leq 60\%)$	5×10^{10}	10^{14}	—	Ω	
Isolation Voltage	BV_S	AC, 1 minute	5000	—	—	Vrms	
		AC, 1 second (in oil)	—	10000	—		
		DC, 1 minute (in oil)	—	10000	—	Vdc	

Fig.1 dv/dt TEST CIRCUIT

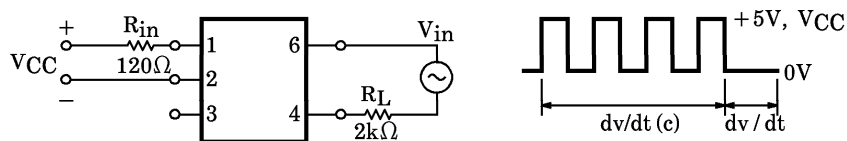

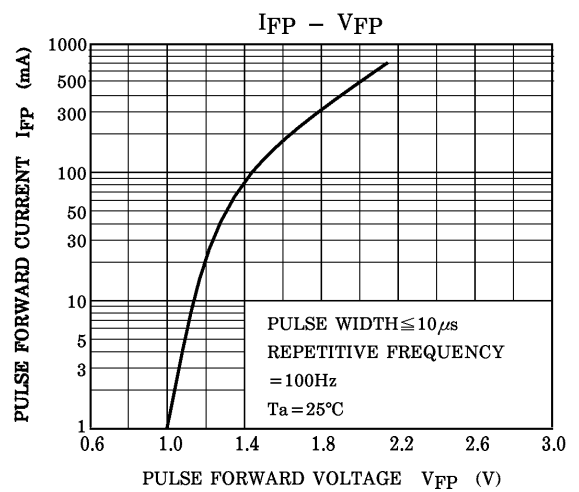
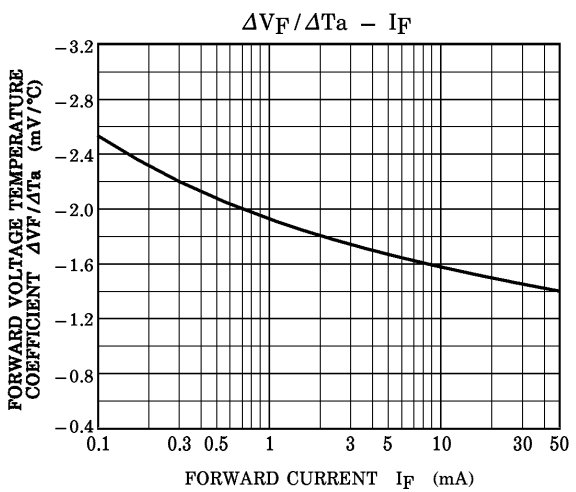
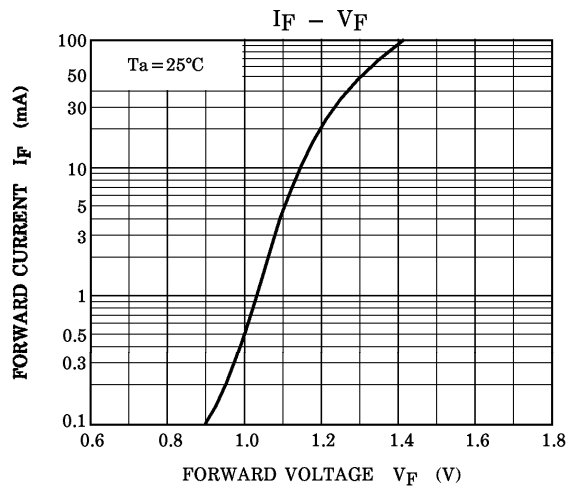
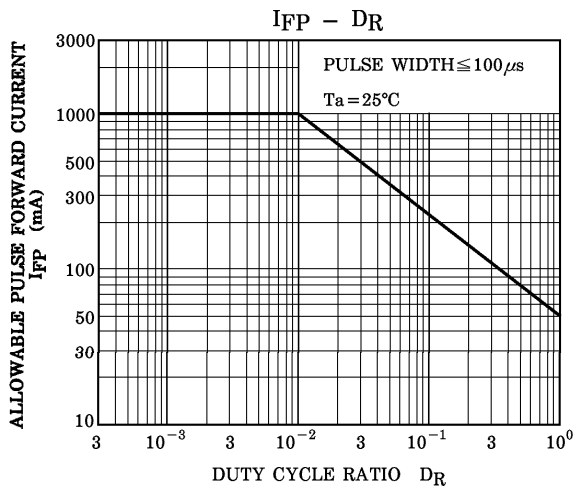
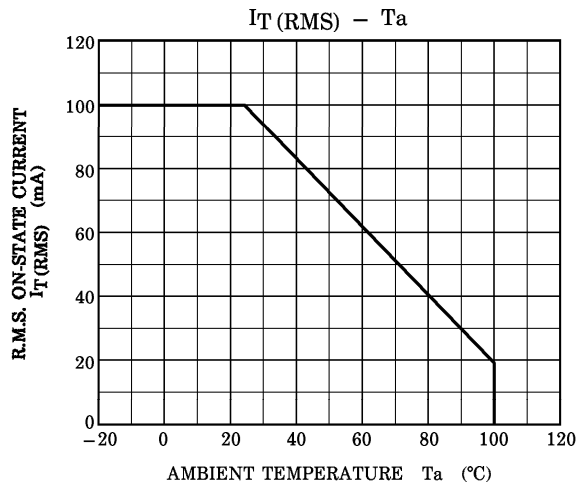
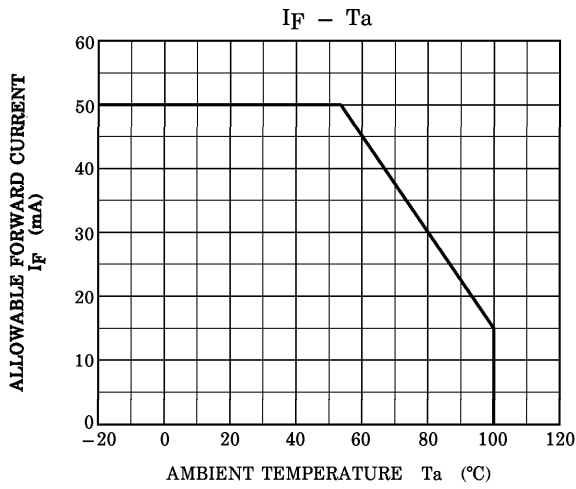

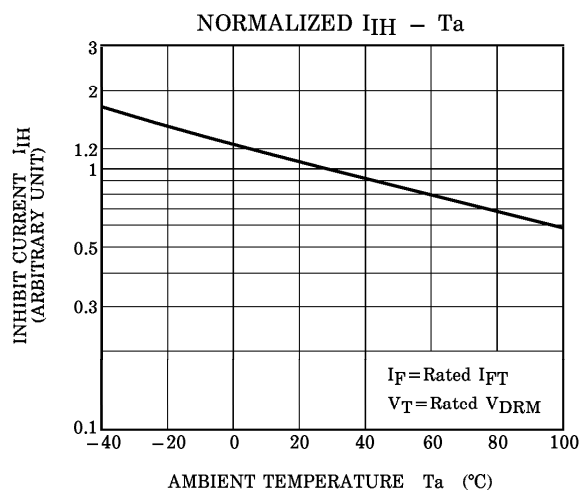
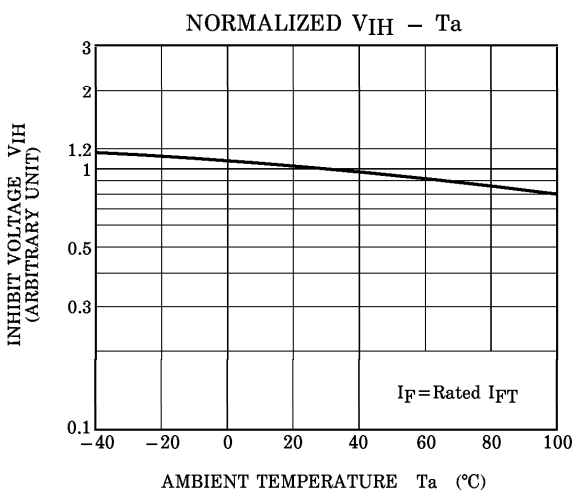
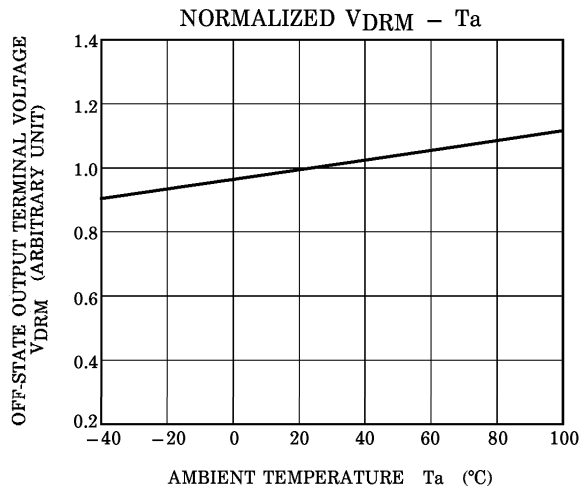
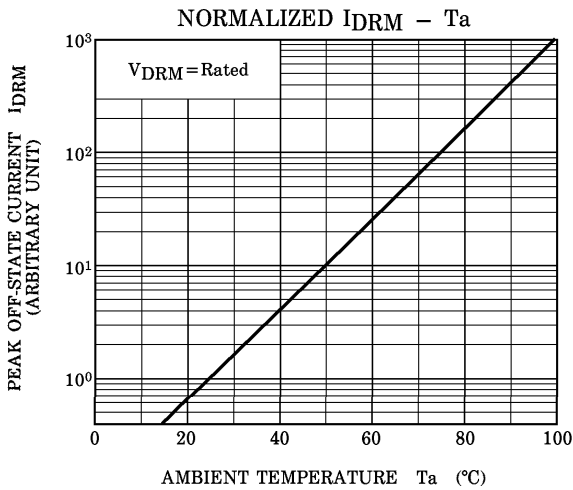
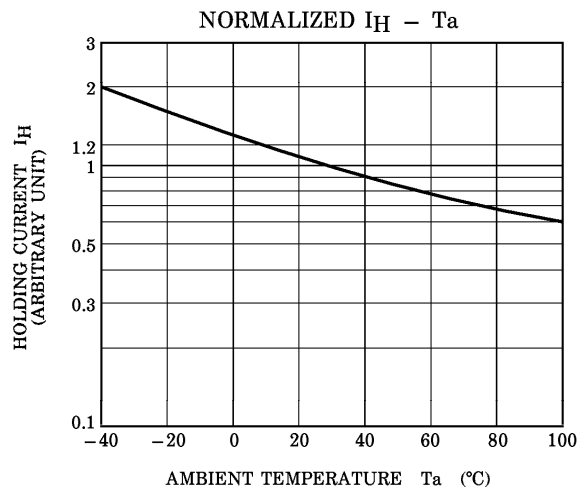
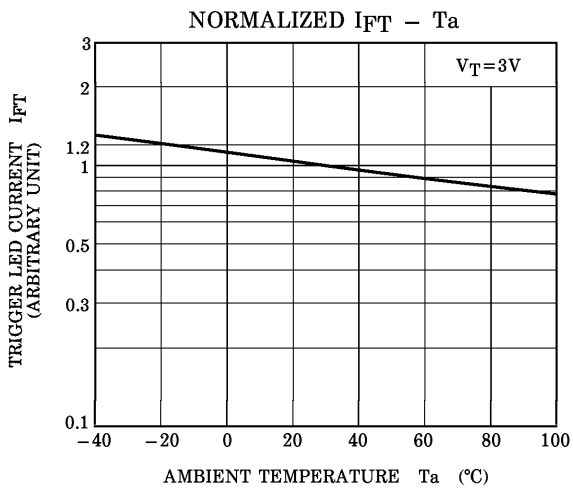

RESTRICTIONS ON PRODUCT USE

000707EBC

- TOSHIBA is continually working to improve the quality and reliability of its products. Nevertheless, semiconductor devices in general can malfunction or fail due to their inherent electrical sensitivity and vulnerability to physical stress. It is the responsibility of the buyer, when utilizing TOSHIBA products, to comply with the standards of safety in making a safe design for the entire system, and to avoid situations in which a malfunction or failure of such TOSHIBA products could cause loss of human life, bodily injury or damage to property. In developing your designs, please ensure that TOSHIBA products are used within specified operating ranges as set forth in the most recent TOSHIBA products specifications. Also, please keep in mind the precautions and conditions set forth in the "Handling Guide for Semiconductor Devices," or "TOSHIBA Semiconductor Reliability Handbook" etc..
- The TOSHIBA products listed in this document are intended for usage in general electronics applications (computer, personal equipment, office equipment, measuring equipment, industrial robotics, domestic appliances, etc.). These TOSHIBA products are neither intended nor warranted for usage in equipment that requires extraordinarily high quality and/or reliability or a malfunction or failure of which may cause loss of human life or bodily injury ("Unintended Usage"). Unintended Usage include atomic energy control instruments, airplane or spaceship instruments, transportation instruments, traffic signal instruments, combustion control instruments, medical instruments, all types of safety devices, etc.. Unintended Usage of TOSHIBA products listed in this document shall be made at the customer's own risk.
- Gallium arsenide (GaAs) is a substance used in the products described in this document. GaAs dust and fumes are toxic. Do not break, cut or pulverize the product, or use chemicals to dissolve them. When disposing of the products, follow the appropriate regulations. Do not dispose of the products with other industrial waste or with domestic garbage.
- The products described in this document are subject to the foreign exchange and foreign trade laws.
- The information contained herein is presented only as a guide for the applications of our products. No responsibility is assumed by TOSHIBA CORPORATION for any infringements of intellectual property or other rights of the third parties which may result from its use. No license is granted by implication or otherwise under any intellectual property or other rights of TOSHIBA CORPORATION or others.
- The information contained herein is subject to change without notice.