

QM30HC-2H

INDUCTION HEATER USE
NON-INSULATED TYPE

QM30HC-2H



- **IC** Collector current **30A**
- **VCEX** Collector-emitter voltage **1600V**
- **hFE** DC current gain **75**
- **Non-Insulated Type**

APPLICATION

Induction heater for cooking

OUTLINE DRAWING & CIRCUIT DIAGRAM

Dimensions in mm

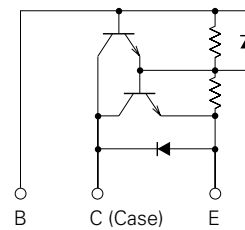
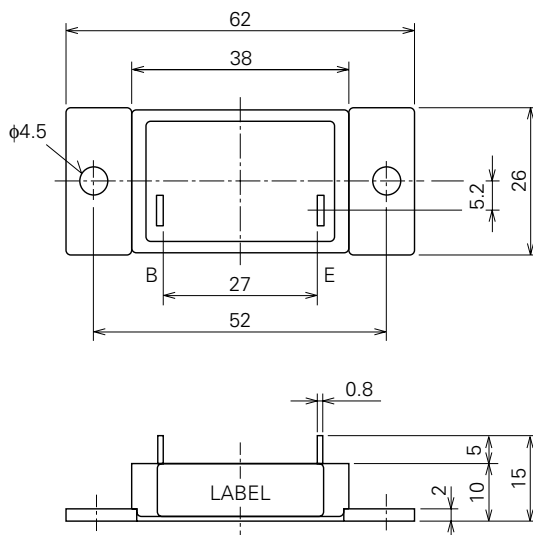

QM30HC-2H

INDUCTION HEATER USE

NON-INSULATED TYPE

ABSOLUTE MAXIMUM RATINGS (T_j=25°C, unless otherwise noted)

Symbol	Parameter	Conditions	Ratings	Unit
VCEX (SUS)	Collector-emitter voltage	I _C =1A, V _{EB} =2V	—	V
VCEX	Collector-emitter voltage	V _{EB} =2V	1600	V
VCBO	Collector-base voltage	Emitter open	1600	V
VEBO	Emitter-base voltage	Collector open	10	V
I _C	Collector current	DC	30	A
-I _C	Collector reverse current	DC (forward diode current)	30	A
P _C	Collector dissipation	T _C =25°C	310	W
I _B	Base current	DC	5	A
-I _{CSM}	Surge collector reverse current (forward diode current)	Peak value of one cycle of 60Hz (half wave)	300	A
T _j	Junction temperature		-40~+150	°C
T _{stg}	Storage temperature		-40~+125	°C
V _{iso}	Isolation voltage	Charged part to case, AC for 1 minute	—	V
—	Mounting torque	Mounting screw M4	0.98~1.47	N·m
—	Weight	Typical value	10~15	kg·cm
—	Weight	Typical value	50	g

ELECTRICAL CHARACTERISTICS (T_j=25°C, unless otherwise noted)

Symbol	Parameter	Test conditions	Limits			Unit
			Min.	Typ.	Max.	
I _C EX	Collector cutoff current	V _{CE} =1600V, V _{EB} =2V	—	—	1.0	mA
I _C BO	Collector cutoff current	V _{CB} =1600V, Emitter open	—	—	1.0	mA
I _E BO	Emitter cutoff current	V _{EB} =10V	—	—	400	mA
V _{CE} (sat)	Collector-emitter saturation voltage	I _C =30A, I _B =2A	—	—	2.0	V
V _{BE} (sat)	Base-emitter saturation voltage		—	—	2.5	V
-V _{CEO}	Collector-emitter reverse voltage	-I _C =30A (diode forward voltage)	—	—	1.5	V
h _{FE}	DC current gain	I _C =30A, V _{CE} =5V	75	—	—	—
t _{on}	Switching time	V _{CC} =100V, I _C =30A, I _{B1} =2A, I _{B2} =-5A	—	—	4.0	μs
t _s			—	—	5.0	μs
t _f			—	—	3.0	μs
R _{th} (j-c) Q	Thermal resistance (junction to case)	Transistor part	—	—	0.4	°C/W
R _{th} (j-c) R		Diode part	—	—	0.8	°C/W
R _{th} (c-f)	Contact thermal resistance (case to fin)	Conductive grease applied	—	—	0.25	°C/W

QM30HC-2H

INDUCTION HEATER USE
NON-INSULATED TYPE

PERFORMANCE CURVES

COMMON EMITTER OUTPUT CHARACTERISTICS (TYPICAL)

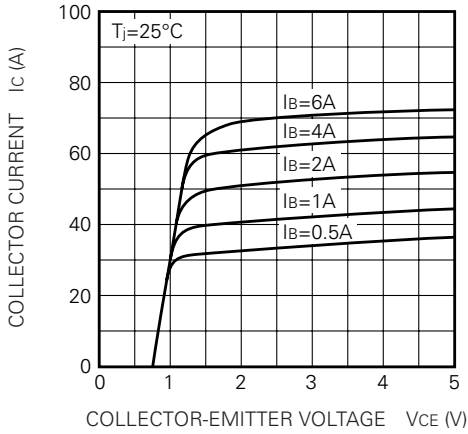

DC CURRENT GAIN VS. COLLECTOR CURRENT (TYPICAL)

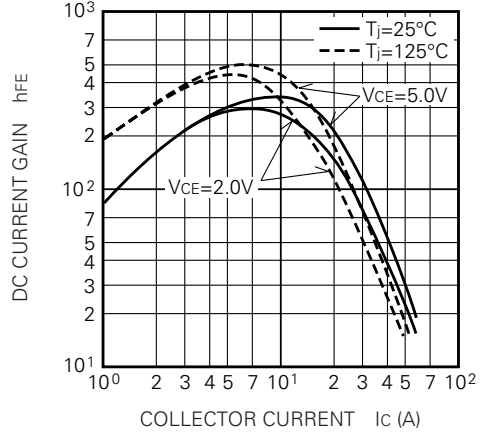

COMMON EMITTER INPUT CHARACTERISTIC (TYPICAL)

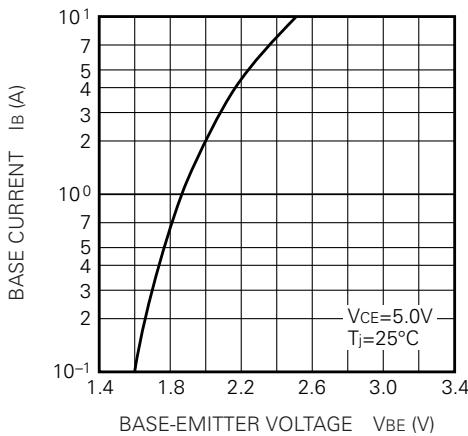

SATURATION VOLTAGE CHARACTERISTICS (TYPICAL)

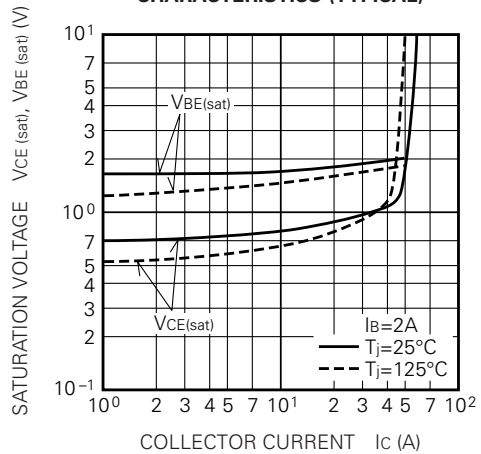

COLLECTOR-EMITTER SATURATION VOLTAGE (TYPICAL)

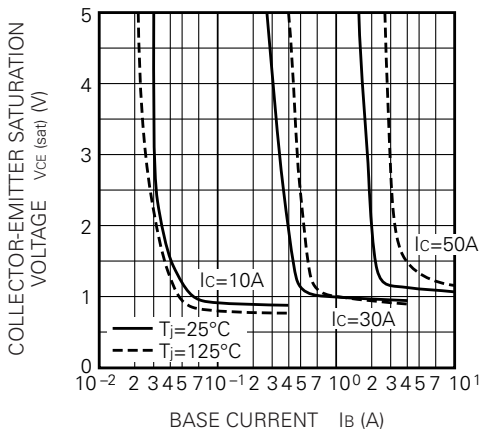

SWITCHING TIME VS. COLLECTOR CURRENT (TYPICAL)

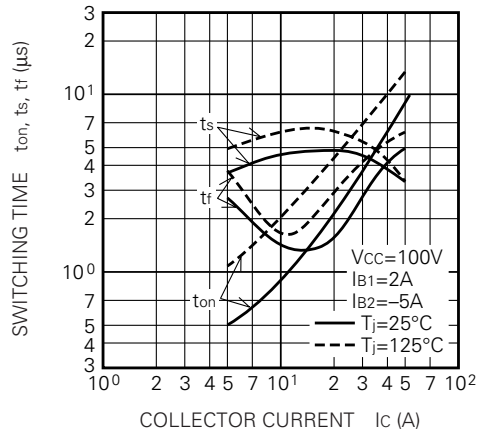

QM30HC-2H

INDUCTION HEATER USE
NON-INSULATED TYPE

SWITCHING TIME VS. BASE CURRENT (TYPICAL)

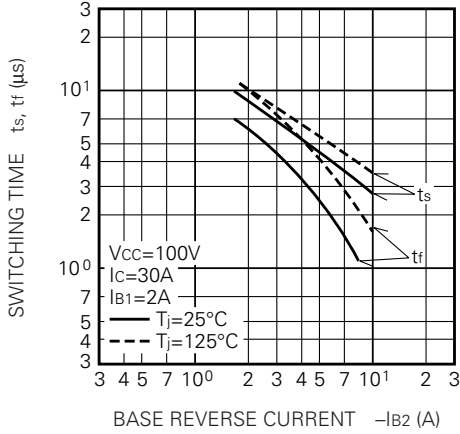

FORWARD BIAS SAFE OPERATING AREA

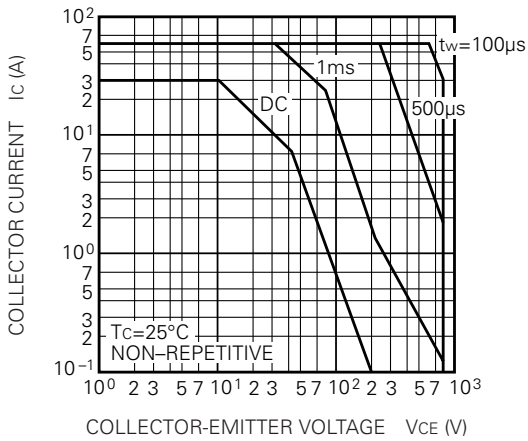

DERATING FACTOR OF F. B. S. O. A.

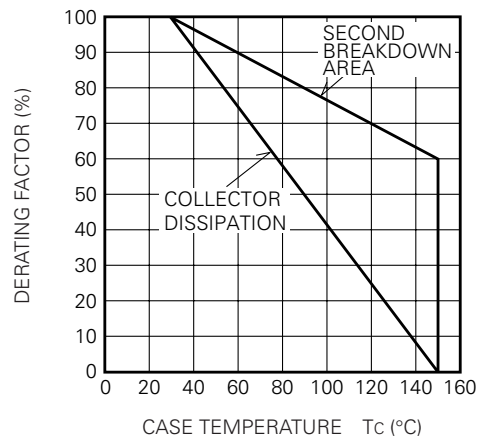

TRANSIENT THERMAL IMPEDANCE CHARACTERISTIC (TRANSISTOR)

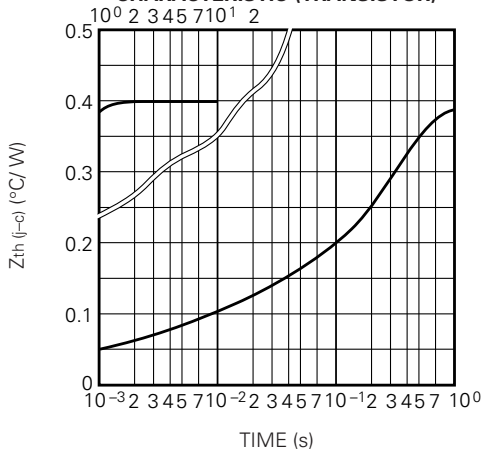

REVERSE COLLECTOR CURRENT VS. COLLECTOR-EMITTER REVERSE VOLTAGE (DIODE FORWARD CHARACTERISTICS) (TYPICAL)

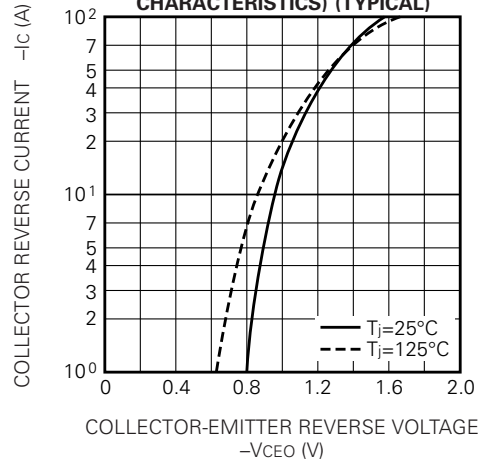

QM30HC-2H

INDUCTION HEATER USE
NON-INSULATED TYPE

**RATED SURGE COLLECTOR REVERSE CURRENT
(DIODE FORWARD SURGE CURRENT)**

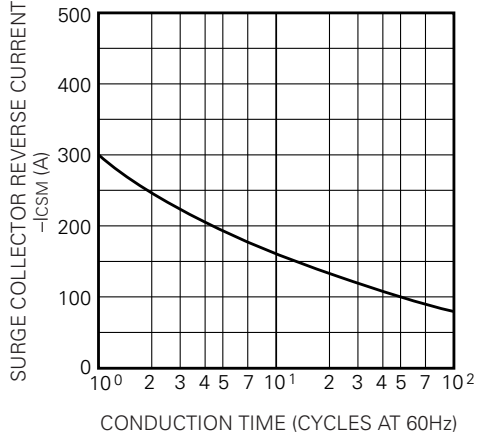

**TRANSIENT THERMAL IMPEDANCE
CHARACTERISTIC (DIODE)**

