

# THYRISTOR MODULE

## AK25GB40/80



UL;E76102 (M)

Power Thyristor Module **AK25GB** series are designed for various rectifier circuits and power controls. For your circuit application, following internal connections and wide voltage ratings up to 800V are available, and electrically isolated mounting base make your mechanical design easy.

### Isolated mounting base

- $I_{T(AV)}$  25A,  $I_{T(RMS)}$  55A,  $I_{TSM}$  55A
- $di/dt$  100 A/ $\mu$ s
- $dv/dt$  500V/ $\mu$ s

### (Applications)

- AC/DC motor drives
- Heater controls
- Light dimmers
- Static switches

### Internal Configurations

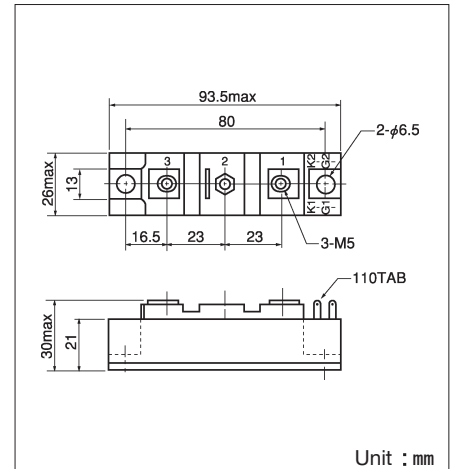
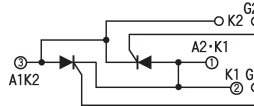

### Maximum Ratings

( $T_j=25^\circ\text{C}$  unless otherwise specified)

| Symbol    | Item                              | Ratings  |          | Unit |
|-----------|-----------------------------------|----------|----------|------|
|           |                                   | AK25GB40 | AK25GB80 |      |
| $V_{DRM}$ | Repetitive Peak Off-State Voltage | 400      | 800      | V    |

| Symbol       | Item                                      | Conditions   | Ratings                           | Unit                   |                 |
|--------------|---|--|-----------------------------------|------------------------|-----------------|
| $I_{T(AV)}$  | Average On-State Current                  | Single phase, half wave, $180^\circ$ conduction, $T_c : 97^\circ\text{C}$                          | 25                                | A                      |                 |
| $I_{T(RMS)}$ | R.M.S. On-State Current                   | $T_c : 97^\circ\text{C}$   | 55                                | A                      |                 |
| $I_{TSM}$    | Surge On-State Current                    | $1/2$ cycle, 50Hz/60Hz, peak value, non-repetitive   | 450/500                           | A                      |                 |
| $I^2t$       | $I^2t$                                    | Value for one cycle of surge current   | 1000                              | $\text{A}^2\text{S}$   |                 |
| $P_{GM}$     | Peak Gate Power Dissipation               |  | 10                                | W                      |                 |
| $P_{G(AV)}$  | Average Gate Power Dissipation            |  | 1                                 | W                      |                 |
| $I_{FGM}$    | Peak Gate Current                         |  | 3                                 | A                      |                 |
| $V_{FGM}$    | Peak Gate Voltage (Forward)               |  | 10                                | V                      |                 |
| $V_{RGM}$    | Peak Gate Voltage (Reverse)               |  | 5                                 | V                      |                 |
| $di/dt$      | Critical Rate of Rise of On-State Current | $I_G=100\text{mA}$ , $T_j=25^\circ\text{C}$ , $V_D=1/2V_{DRM}$ , $dI_G/dt=0.1\text{A}/\mu\text{s}$ | 100                               | $\text{A}/\mu\text{s}$ |                 |
| $V_{ISO}$    | Isolation Breakdown Voltage (R.M.S.)      | A.C. 1 minute  | 2500                              | V                      |                 |
| $T_j$        | Operating Junction Temperature            |  | $-40 \sim +125$                   | $^\circ\text{C}$       |                 |
| $T_{stg}$    | Storage Temperature                       |  | $-40 \sim +125$                   | $^\circ\text{C}$       |                 |
|              | Mounting Torque                           | Mounting (M6)  | Recommended Value 2.5~3.9 (25~40) | 4.7 (48)               | N·m<br>(kgf·cm) |
|              |   | Terminal (M5)  | Recommended Value 1.5~2.5 (15~25) | 2.7 (28)               |                 |
|              | Mass                                      | Typical Value  | 170                               | g                      |                 |

### Electrical Characteristics

| Symbol          | Item   | Conditions  | Ratings | Unit                      |
|-----------------|--|---|---------|---------------------------|
| $I_{DRM}$       | Repetitive Peak Off-State Current, max.          | at $V_{DRM}$ , Single phase, half wave, $T_j=125^\circ\text{C}$   | 8       | mA                        |
| $V_{TM}$        | Peak On-State Voltage, max.                      | On-State Current 75A, $T_j=125^\circ\text{C}$ Inst. measurement   | 1.50    | V                         |
| $I_{GT}/V_{GT}$ | Gate Trigger Current/Voltage, max.               | $T_j=25^\circ\text{C}$ , $I_T=1\text{A}$ , $V_D=6\text{V}$  | 50/3    | mA/V                      |
| $V_{GD}$        | Non-Trigger Gate, Voltage, min.                  | $T_j=125^\circ\text{C}$ , $V_D=1/2V_{DRM}$  | 0.25    | V                         |
| $t_{gt}$        | Turn On Time, max.                               | $I_T=25\text{A}$ , $I_G=100\text{mA}$ , $T_j=25^\circ\text{C}$ , $V_D=1/2V_{DRM}$ , $dI_G/dt=0.1\text{A}/\mu\text{s}$ | 10      | $\mu\text{s}$             |
| $dv/dt$         | Critical Rate of Rise of Off-State Voltage, min. | $T_j=125^\circ\text{C}$ , $V_D=2/3V_{DRM}$ , Exponential wave.  | 500     | $\text{V}/\mu\text{s}$    |
| $I_H$           | Holding Current, typ.                            | $T_j=25^\circ\text{C}$  | 50      | mA                        |
| $I_L$           | Latching Current, typ.                           | $T_j=25^\circ\text{C}$  | 100     | mA                        |
| $R_{th(j-c)}$   | Thermal Impedance, max.                          | Junction to case, per $1/2$ Module  | 0.80    | $^\circ\text{C}/\text{W}$ |
|                 |  | Junction to case, per 1 Module  | 0.40    |                           |

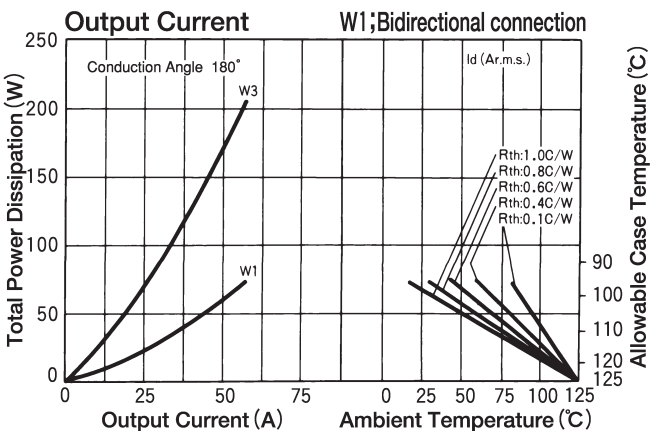
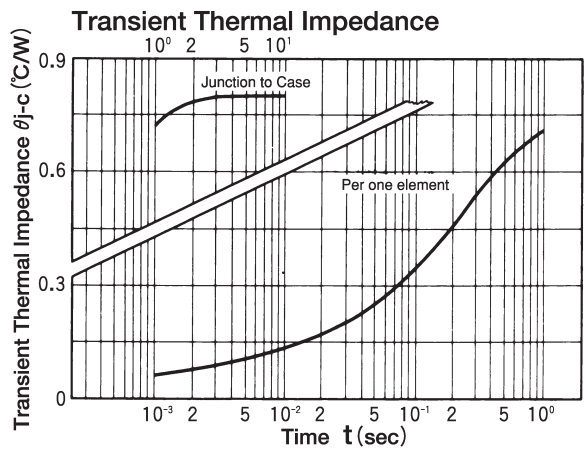
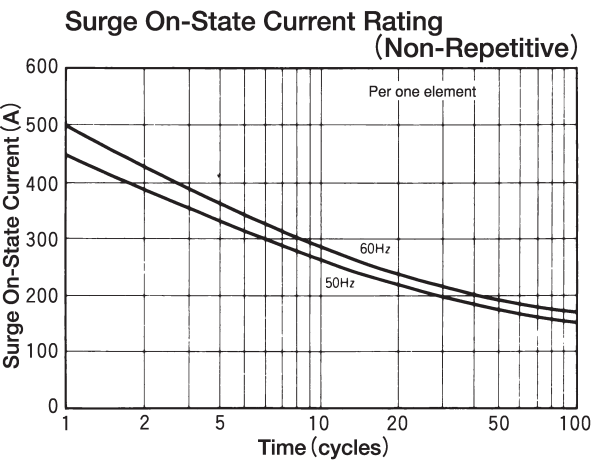
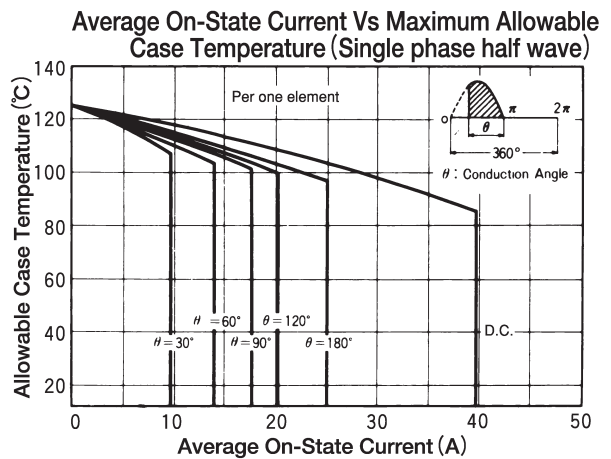
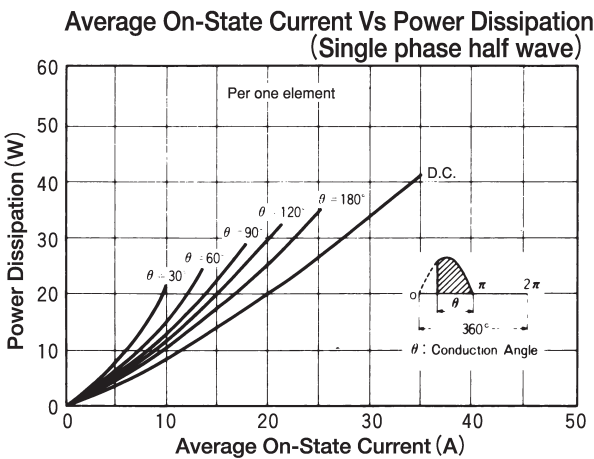
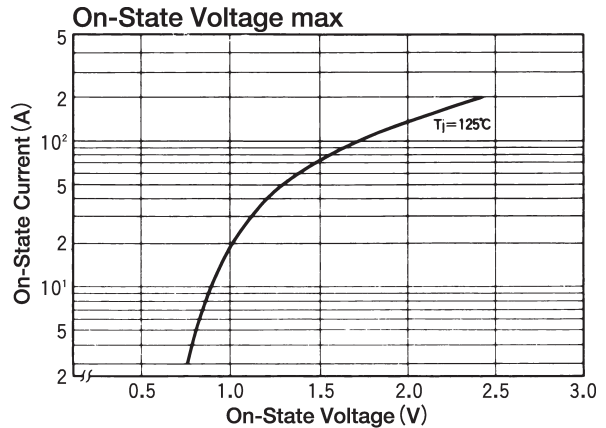
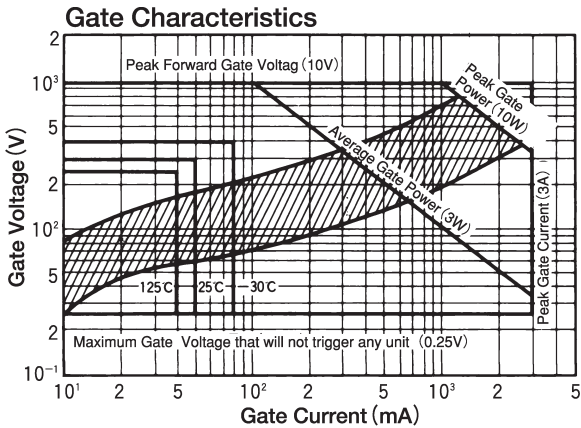

B6; Six pulse bridge connection  
 W3; Three phase bidirectional connection

