

# CM20MD-12H

MEDIUM POWER SWITCHING USE  
INSULATED TYPE

## CM20MD-12H

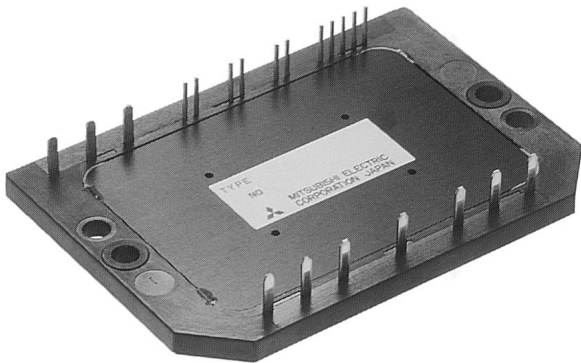

- IC ..... 20A
- VCES ..... 600V
- Insulated Type
- CIB Module
- 3φ Inverter+3φ Converter+Brake
- UL Recognized

Yellow Card No. E80276 (N)  
File No. E80271

## APPLICATION

AC & DC motor controls, General purpose inverters, Servo controls, NC, Robotics

## OUTLINE DRAWING & CIRCUIT DIAGRAM

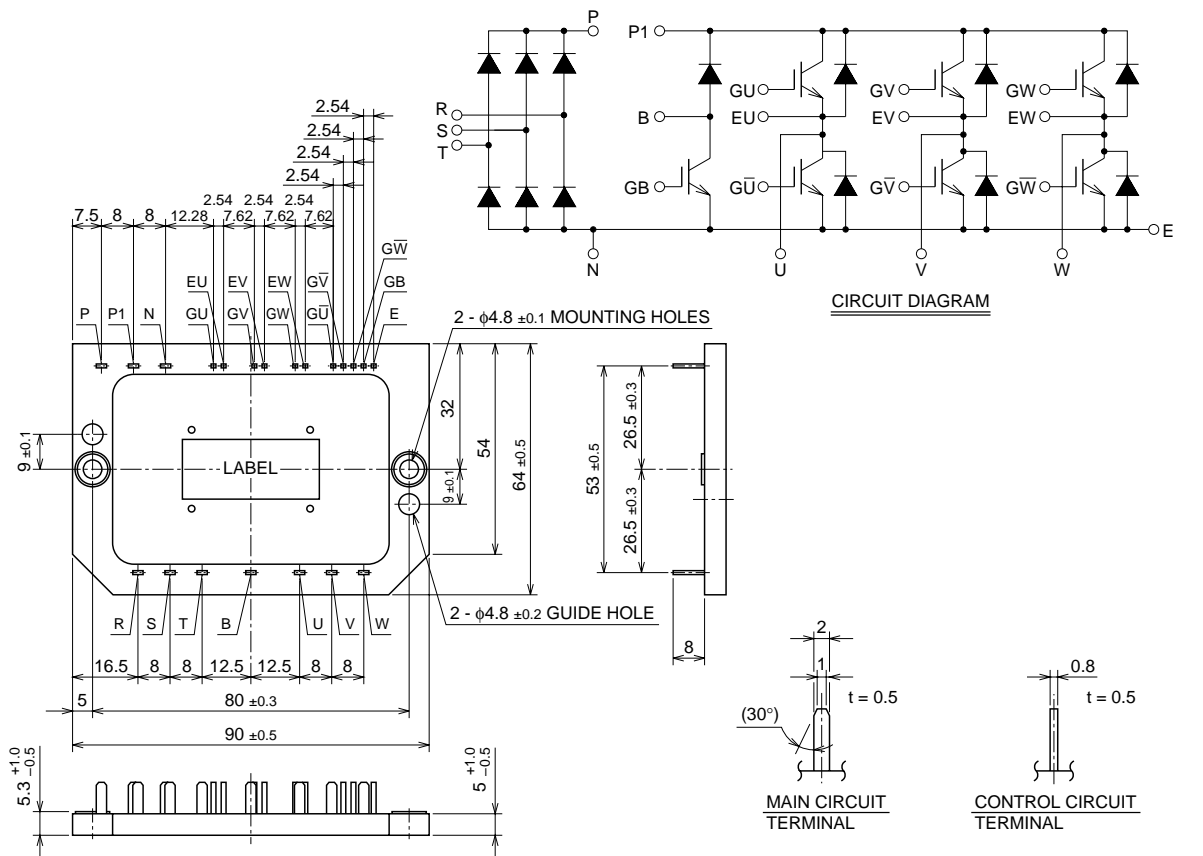

Note. Not use the guiding holes to mount on the cooling fin.

## CM20MD-12H

MEDIUM POWER SWITCHING USE  
INSULATED TYPE**MAXIMUM RATINGS** ( $T_j = 25^\circ\text{C}$ )  
**INVERTER PART**

Symbol	Parameter	Condition	Rating	Unit
V <sub>CES</sub>	Collector-emitter voltage	G – E Short	600	V
V <sub>GES</sub>	Gate-emitter voltage	C – E Short	±20	V
I <sub>C</sub>	Collector Current	T <sub>C</sub> = 25°C	20	A
I <sub>CM</sub>		PULSE (Note. 2)	40	A
I <sub>E</sub> (Note. 1)	Emitter Current	T <sub>C</sub> = 25°C	20	A
I <sub>EM</sub> (Note. 1)		PULSE (Note. 2)	40	A
P <sub>C</sub> (Note. 3)	Maximum collector dissipation	T <sub>f</sub> = 25°C	57	W

**BRAKE PART**

Symbol	Parameter	Condition	Rating	Unit
V <sub>CES</sub>	Collector-emitter voltage	G – E Short	600	V
V <sub>GES</sub>	Gate-emitter voltage	C – E Short	±20	V
I <sub>C</sub>	Collector Current	T <sub>C</sub> = 25°C	20	A
I <sub>CM</sub>		PULSE (Note. 2)	40	A
P <sub>C</sub> (Note. 3)	Maximum Collector dissipation	T <sub>f</sub> = 25°C	57	W
V <sub>RRM</sub>	Repetitive peak reverse voltage	Clamp diode part	600	V
I <sub>FM</sub> (Note. 3)	Forward current	Clamp diode part	20	A

**CONVERTER PART**

Symbol	Parameter	Condition	Rating	Unit
V <sub>RRM</sub>	Repetitive peak reverse voltage		800	V
E <sub>a</sub>	Recommended AC input voltage		220	V
I <sub>O</sub>	DC output current	3 $\phi$ rectifying circuit	20	A
I <sub>FSM</sub>	Surge (non-repetitive) forward current	1 cycle at 60Hz, peak value Non-repetitive	200	A
I <sup>2</sup> t	I <sup>2</sup> t for fusing	Value for one cycle of surge current	165	A <sup>2</sup> s

**COMMON RATING**

Symbol	Parameter	Condition	Rating	Unit
T <sub>j</sub>	Junction temperature		-40 ~ +150	°C
T <sub>stg</sub>	Storage temperature		-40 ~ +125	°C
V <sub>iso</sub>	Isolation voltage	AC 1 min.	2500	V
—	Mounting torque	Mounting M4 screw	1.47 ~ 1.96	N · m
—	Weight	Typical value	60	g

## CM20MD-12H

MEDIUM POWER SWITCHING USE  
INSULATED TYPEELECTRICAL CHARACTERISTICS ( $T_j = 25^\circ\text{C}$ )  
INVERTER PART

Symbol	Parameter	Test conditions	Limits			Unit	
			Min.	Typ.	Max.		
ICES	Collector cutoff current	$V_{CE} = V_{CES}, V_{GE} = 0V$	—	—	1	mA	
$V_{GE(th)}$	Gate-emitter threshold voltage	$I_C = 2mA, V_{CE} = 10V$	4.5	6	7.5	V	
IGES	Gate-emitter cutoff current	$V_{GE} = V_{GES}, V_{CE} = 0V$	—	—	0.5	$\mu A$	
$V_{CE(sat)}$	Collector-emitter saturation voltage	$I_C = 20A, V_{GE} = 15V$ (Note. 4)	$T_j = 25^\circ\text{C}$	—	2.1	2.8	V
			$T_j = 150^\circ\text{C}$	—	2.15	—	
$C_{ies}$	Input capacitance	$V_{CE} = 10V$ $V_{GE} = 0V$	—	—	2.0	nF	
$C_{oes}$	Output capacitance		—	—	1.5	nF	
$C_{res}$	Reverse transfer capacitance		—	—	0.4	nF	
QG	Total gate charge	$V_{CC} = 300V, I_C = 20A, V_{GE} = 15V$	—	60	—	nC	
$t_d(on)$	Turn-on delay time	$V_{CC} = 300V, I_C = 20A$	—	—	120	ns	
$t_r$	Turn-on rise time	$V_{GE1} = V_{GE2} = 15V$	—	—	300	ns	
$t_d(off)$	Turn-off delay time	$R_G = 31\Omega$	—	—	200	ns	
$t_f$	Turn-off fall time	Resistive load	—	—	300	ns	
$V_{EC}$ (Note. 1)	Emitter-collector voltage	$I_E = 20A, V_{GE} = 0V$	—	—	2.8	V	
$t_{rr}$ (Note. 1)	Reverse recovery time	$I_E = 20A, V_{GE} = 0V$	—	—	110	ns	
$Q_{rr}$ (Note. 1)	Reverse recovery charge	$di_e / dt = -40A / \mu s$	—	0.05	—	$\mu C$	
$R_{th(j-f)Q}$ (Note. 5)	Thermal resistance	IGBT part, Per 1/6 module	—	—	2.2	$^\circ\text{C/W}$	
$R_{th(j-f)R}$ (Note. 5)		FWDi part, Per 1/6 module	—	—	3.1	$^\circ\text{C/W}$	

## BRAKE PART

Symbol	Parameter	Condition	Limits			Unit	
			Min.	Typ.	Max.		
ICES	Collector cutoff current	$V_{CE} = V_{CES}, V_{GE} = 0V$	—	—	1	mA	
$V_{GE(th)}$	Gate-emitter threshold voltage	$I_C = 2mA, V_{CE} = 10V$	4.5	6	7.5	V	
IGES	Gate-emitter cutoff current	$V_{GE} = V_{GES}, V_{CE} = 0V$	—	—	0.5	$\mu A$	
$V_{CE(sat)}$	Collector-to-emitter saturation voltage	$I_C = 20A, V_{GE} = 15V$ (Note. 4)	$T_j = 25^\circ\text{C}$	—	2.1	2.8	V
			$T_j = 150^\circ\text{C}$	—	2.15	—	
$C_{ies}$	Input capacitance	$V_{CE} = 10V$ $V_{GE} = 0V$	—	—	2.0	nF	
$C_{oes}$	Output capacitance		—	—	1.5	nF	
$C_{res}$	Reverse transfer capacitance		—	—	0.4	nF	
QG	Total gate charge	$V_{CC} = 300V, I_C = 20A, V_{GE} = 15V$	—	60	—	nC	
VFM	Forward voltage drop	$I_F = 20A$ , Clamp diode part	—	—	1.5	V	
$R_{th(j-f)Q}$ (Note. 5)	Thermal resistance	IGBT part	—	—	2.2	$^\circ\text{C/W}$	
$R_{th(j-f)R}$ (Note. 5)		Clamp diode part	—	—	3.6	$^\circ\text{C/W}$	

## CONVERTER PART

Symbol	Parameter	Condition	Limits			Unit
			Min.	Typ.	Max.	
IRRM	Repetitive reverse current	$V_R = V_{RRM}, T_j = 150^\circ\text{C}$	—	—	8	mA
VFM	Forward voltage drop	$I_F = 20A$	—	—	1.5	V
$R_{th(j-f)}$ (Note. 5)	Thermal resistance	Per 1/6 module	—	—	3.6	$^\circ\text{C/W}$

Note 1.  $I_E$ ,  $V_{EC}$ ,  $t_{rr}$ ,  $Q_{rr}$  &  $di_e/dt$  represent characteristics of the anti-parallel, emitter to collector free-wheel diode.

2. Pulse width and repetition rate should be such that the device junction temp. ( $T_j$ ) does not exceed  $T_{jmax}$  rating.

3. Junction temperature ( $T_j$ ) should not increase beyond  $150^\circ\text{C}$ .

4. Pulse width and repetition rate should be such as to cause negligible temperature rise.

5. Thermal resistance is specified under following conditions.

- The conductive grease applied, between module and fin.
- Al plate is used as fin.

# CM20MD-12H

MEDIUM POWER SWITCHING USE  
INSULATED TYPE

## PERFORMANCE CURVES

**OUTPUT CHARACTERISTICS (TYPICAL)**

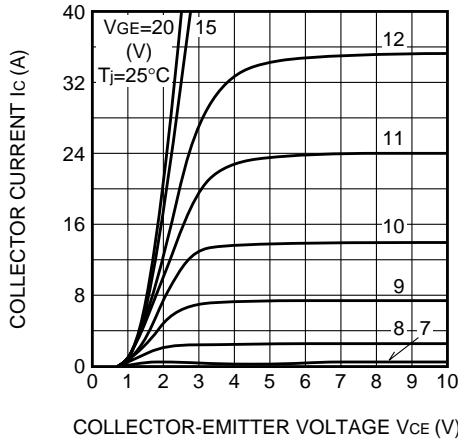

**TRANSFER CHARACTERISTICS (TYPICAL)**

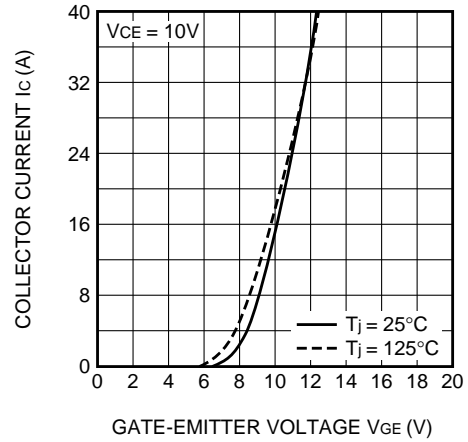

**COLLECTOR-EMITTER SATURATION VOLTAGE CHARACTERISTICS (TYPICAL)**

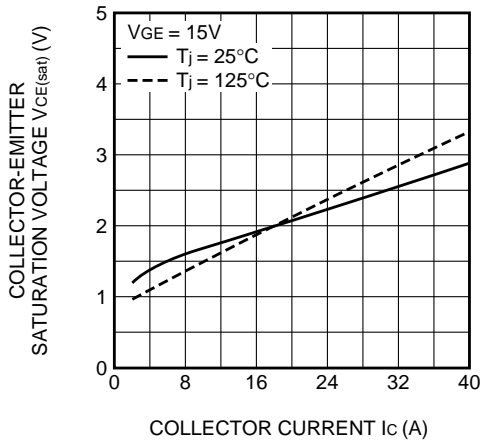

**COLLECTOR-EMITTER SATURATION VOLTAGE CHARACTERISTICS (TYPICAL)**

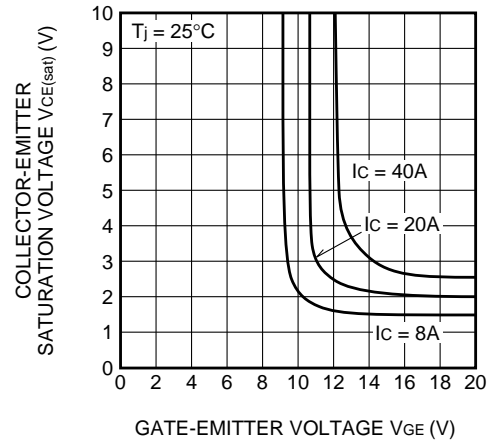

**FREE-WHEEL DIODE FORWARD CHARACTERISTICS (TYPICAL)**

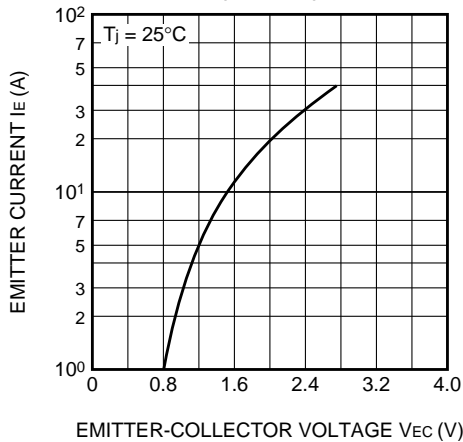

**CAPACITANCE VS. Vce (TYPICAL)**

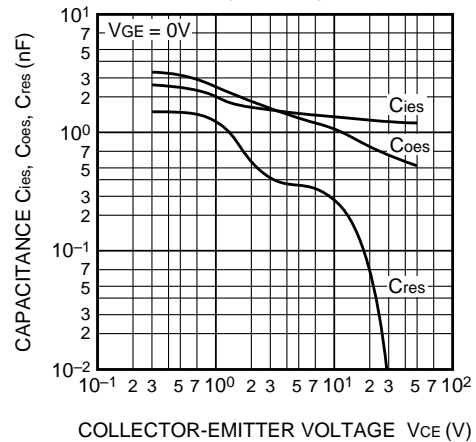

# CM20MD-12H

MEDIUM POWER SWITCHING USE  
INSULATED TYPE

**HALF-BRIDGE SWITCHING CHARACTERISTICS (TYPICAL)**

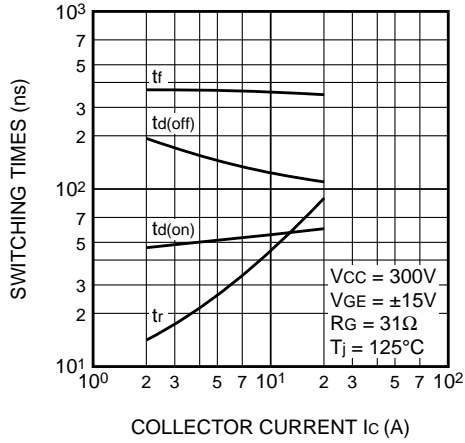

**REVERSE RECOVERY CHARACTERISTICS OF FREE-WHEEL DIODE (TYPICAL)**

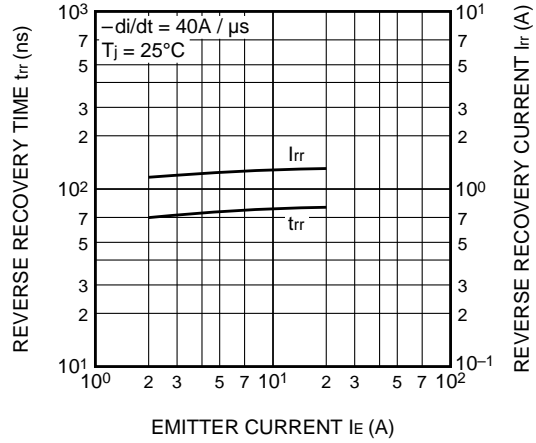

**TRANSIENT THERMAL IMPEDANCE CHARACTERISTICS (IGBT part)**

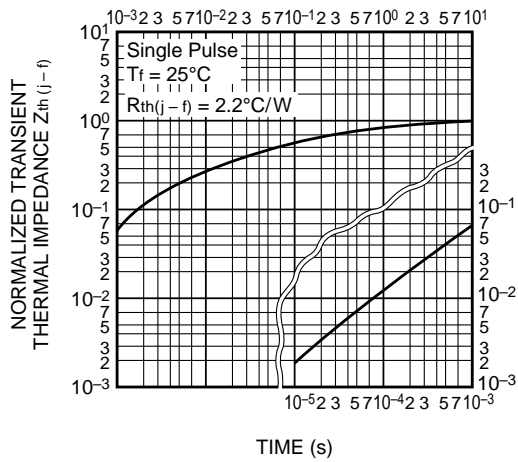

**TRANSIENT THERMAL IMPEDANCE CHARACTERISTICS (FWDi part)**

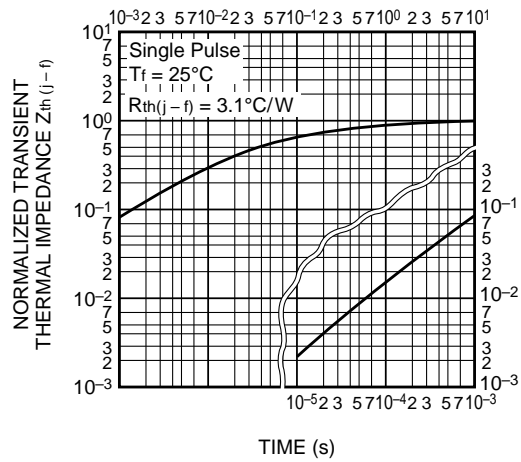

**V<sub>GE</sub> - GATE CHARGE (TYPICAL)**

