

< Silicon RF Power MOS FET (Discrete) >

# RD35HUP2

RoHS Compliance, Silicon MOSFET Power Transistor, 175MHz, 530MHz, 35W, 12.5V

## DESCRIPTION

RD35HUP2 is a MOS FET type transistor specifically designed for VHF/UHF RF power amplifiers applications.

## FEATURES

1. Supply with Tape and Reel. 500 Units per Reel
2. Employing Mold Package
3. High Power and High Efficiency  
 $P_{out}=35W$  typ, Drain Effi.=70.0% typ  
@  $V_{DD}=12.5V$ ,  $I_{DQ}=0.5A$ ,  $P_{in}=3W$ ,  $f=175MHz$   
 $P_{out}=35W$  typ, Drain Effi.=64.0% typ  
@  $V_{DD}=12.5V$ ,  $I_{DQ}=0.5A$ ,  $P_{in}=3W$ ,  $f=530MHz$
4. Integrated gate protection diode.

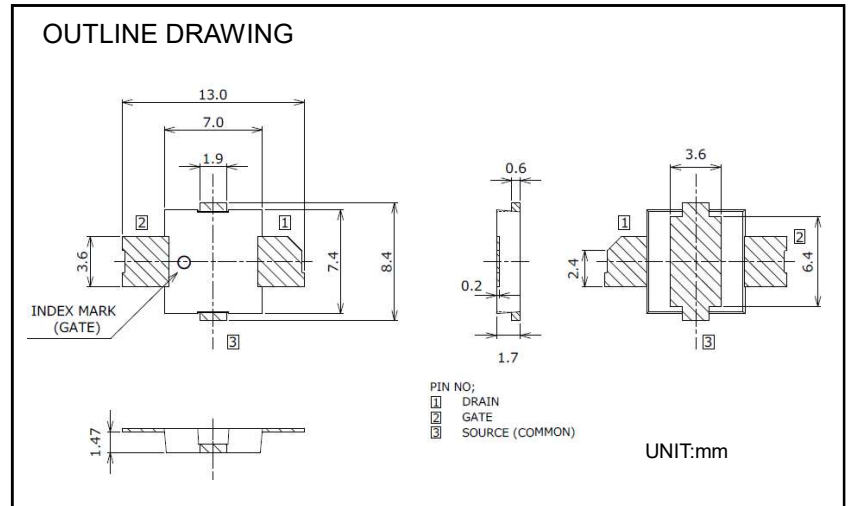

## APPLICATION

For output stage of high power amplifiers in VHF/UHF-band mobile radio sets.

## RoHS COMPLIANT

RD35HUP2 is EU RoHS compliant.

RoHS Directive: 2011/65/EU, (EU)2015/863

**RD35HUP2**

RoHS Compliance, Silicon MOSFET Power Transistor, 175MHz, 530MHz, 35W, 12.5V

**MAXIMUM RATINGS** ( $T_a = +25^\circ\text{C}$ ,  $Z_G = Z_L = 50\Omega$  UNLESS OTHERWISE SPECIFIED)

SYMBOL	PARAMETER	CONDITIONS	RATINGS	UNIT
$V_{DSS}$	Drain to Source Voltage	$V_{GS}=0V$	40	V
$V_{GSS}$	Gate to Source Voltage	$V_{DS}=0V$	-5/+10	V
$P_{ch}$	Channel Dissipation	With infinite heat sink	224	W
$P_{in}$	Input Power	-	6	W
$I_D$	Drain Current	-	10	A
$T_{ch}$	Channel Temperature	-	175	$^\circ\text{C}$
$T_{stg}$	Storage Temperature	-	-40 to +175	$^\circ\text{C}$

Note : Each Maximum Ratings is Guaranteed Independently.

**ELECTRICAL CHARACTERISTICS** ( $T_a = +25^\circ\text{C}$ ,  $Z_G = Z_L = 50\Omega$  UNLESS OTHERWISE SPECIFIED)

SYMBOL	PARAMETER	CONDITIONS	LIMITS			UNIT
			MIN.	TYP.	MAX.	
$I_{DSS}$	Zero Gate Voltage Drain Current	$V_{DS}=37V$ , $V_{GS}=0V$	-	-	150	$\mu\text{A}$
$I_{GSS}$	Gate to Source Leak Current	$V_{GS}=10V$ , $V_{DS}=0V$	-	-	2.5	$\mu\text{A}$
$V_{TH}$	Gate Threshold Voltage	$V_{DS}=12V$ , $I_{DS}=1\text{mA}$	1.6	2.0	2.4	V
$P_{out}$	Output Power	$f=530\text{MHz}^{*1}$ , $V_{DD}=12.5V$ ,	-	35	-	W
$\eta_D$	Drain Efficiency	$P_{in}=3.0W$ , $I_{DQ}=0.5A$	-	55	-	%
VSWRT1 <sup>*3</sup>	Load VSWR Tolerance	Load VSWR=65:1(All Phase), $V_{DD}=16.3V$ , $P_{in}=1W$ ( $Z_G=Z_L=50\Omega$ ) $f=135\text{MHz}^{*2}$ , $I_{DQ}=0.5A$	No destroy			-
VSWRT2	Load VSWR Tolerance	Load VSWR=20:1(All Phase), $V_{DD}=16.3V$ increased after $P_{out}$ adjusted to 40W( $Z_G=Z_L=50\Omega$ ) by $P_{in}$ (under $f=135\text{MHz}^{*2}$ , $V_{DD}=12.5V$ , and $I_{DQ}=0.5A$ )	No destroy			-

Note: Above parameters, ratings, limits and conditions are subject to change.

\*1 In Mitsubishi UHF Evaluation Board

\*2 In Mitsubishi VHF Evaluation Board

\*3 This parameter is sampling check (22pcs / Wafer·Lot).

**TEMPERATURE CHARACTERISTICS** ( $T_a = +25^\circ\text{C}$  UNLESS OTHERWISE SPECIFIED)

SYMBOL	PARAMETER	CONDITIONS	LIMITS			UNIT
			MIN	TYP.	MAX	
$R_{th(j-c)}$ <sup>*4</sup>	Thermal Resistance	Junction to Case	-	0.33	0.67	$^\circ\text{C/W}$

\*4 This parameter is sampling check (22pcs / Assembly Lot).

# RD35HUP2

RoHS Compliance, Silicon MOSFET Power Transistor, 175MHz, 530MHz, 35W, 12.5V

## TYPICAL DC CHARACTERISTICS

(These are only typical curves and devices are not necessarily guaranteed at these curves.)

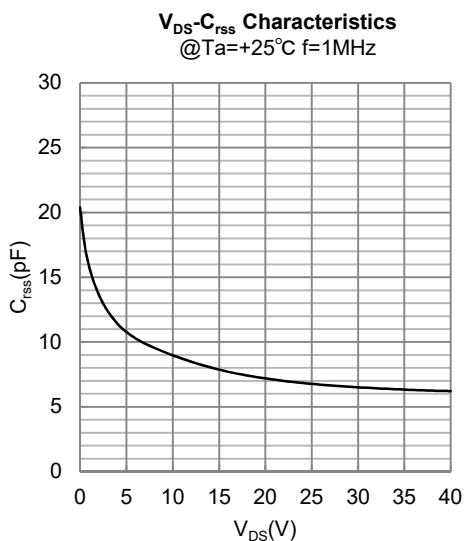
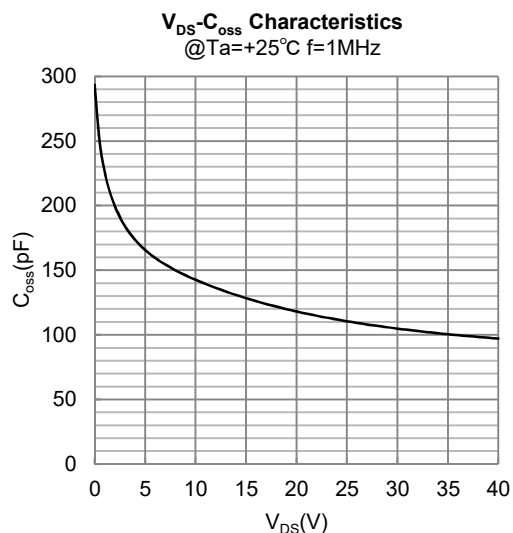
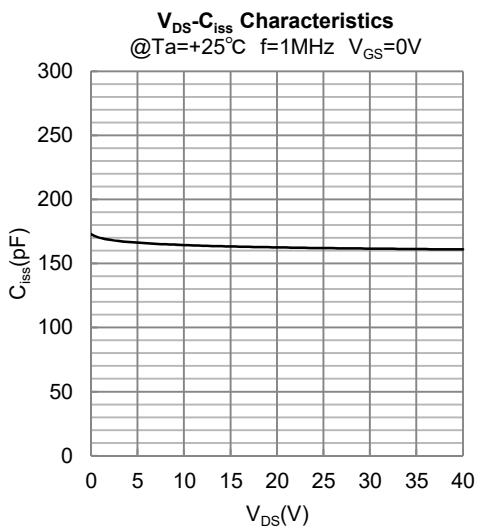
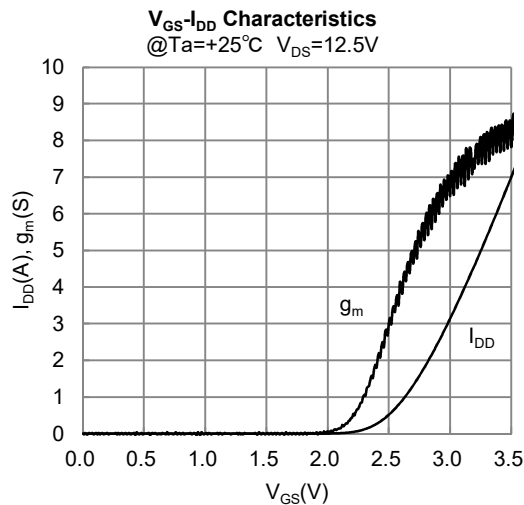
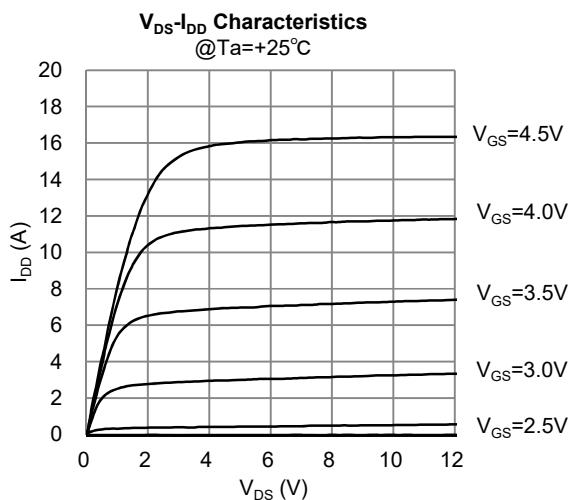

# RD35HUP2

RoHS Compliance, Silicon MOSFET Power Transistor, 175MHz, 530MHz, 35W, 12.5V

## TYPICAL RF CHARACTERISTICS of 135-175 MHz EVB<sup>\*5</sup> ( Frequency vs P<sub>out</sub>, η<sub>d</sub>, G<sub>p</sub> )

(\*5 Evaluation board)

(These are only typical curves and devices are not necessarily guaranteed at these curves.)

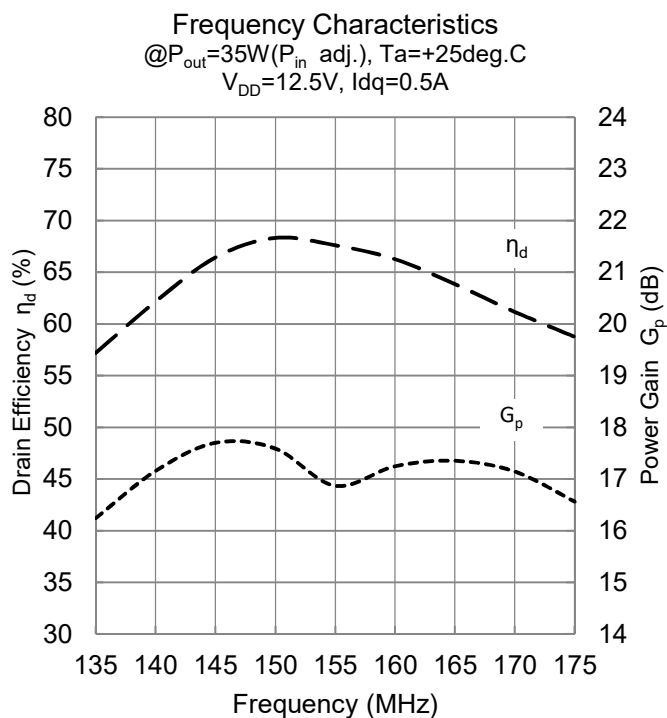
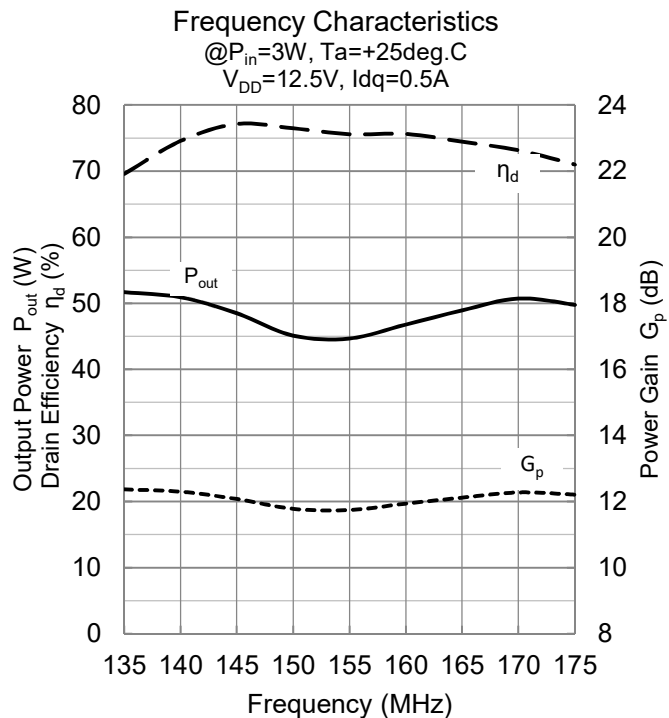

# RD35HUP2

RoHS Compliance, Silicon MOSFET Power Transistor, 175MHz, 530MHz, 35W, 12.5V

## TYPICAL RF CHARACTERISTICS of 135-175 MHz EVB ( $P_{out}$ vs $G_p$ , $\eta_d$ , $I_{DD}$ )

(These are only typical curves and devices are not necessarily guaranteed at these curves.)

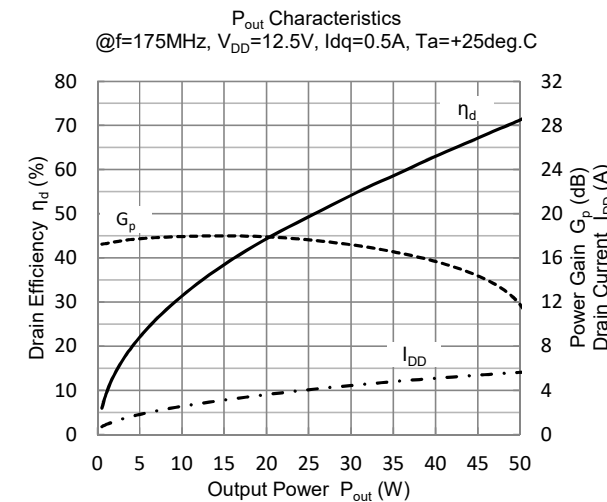
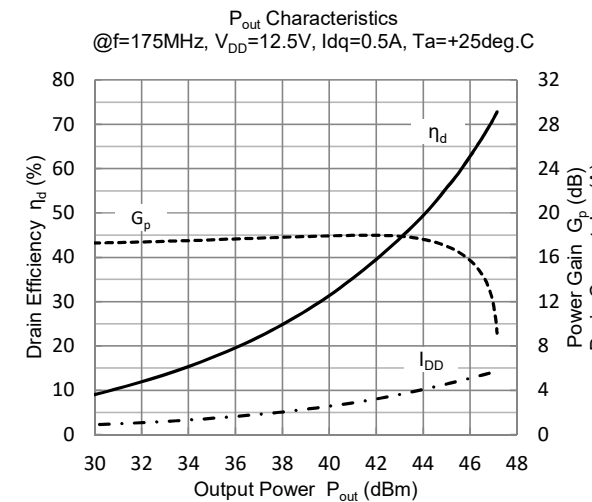
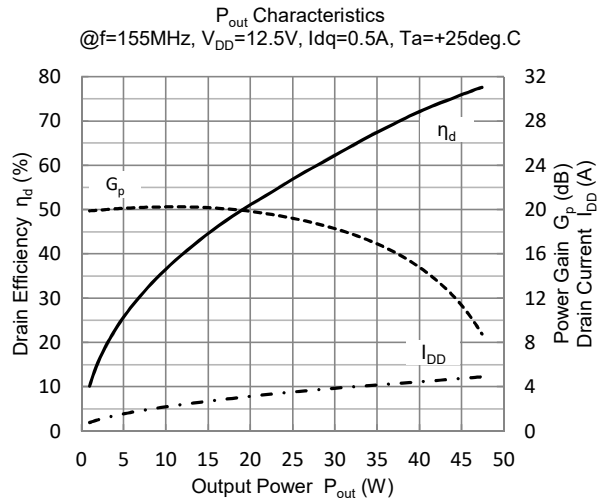
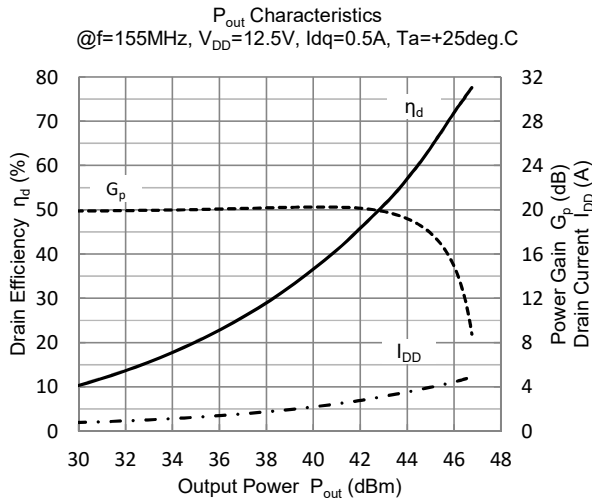
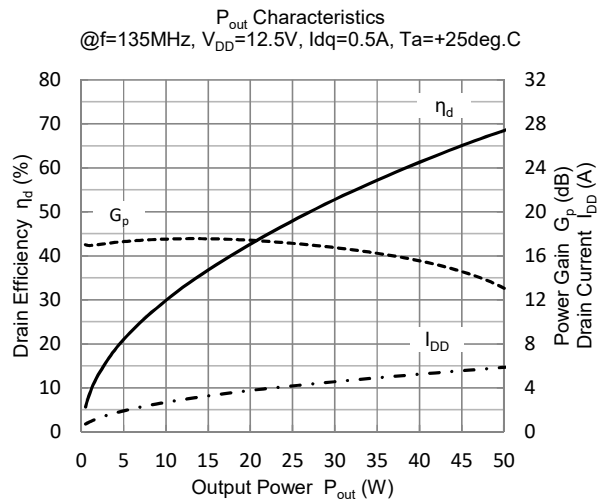
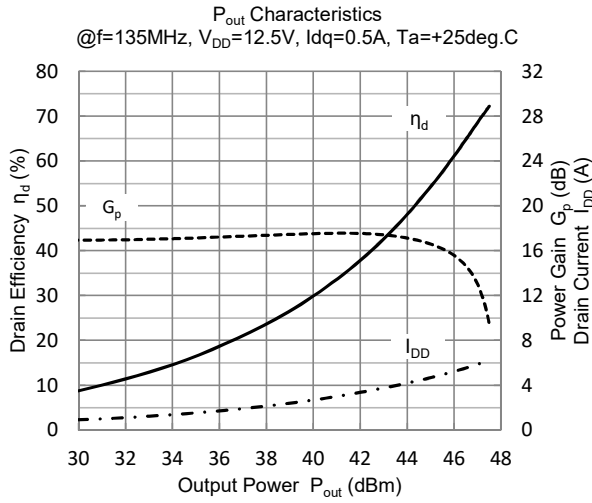

# RD35HUP2

RoHS Compliance, Silicon MOSFET Power Transistor, 175MHz, 530MHz, 35W, 12.5V

## TYPICAL RF CHARACTERISTICS of 135-175 MHz EVB ( $P_{in}$ vs $P_{out}$ , $G_p$ , $\eta_d$ , $I_{DD}$ )

(These are only typical curves and devices are not necessarily guaranteed at these curves.)

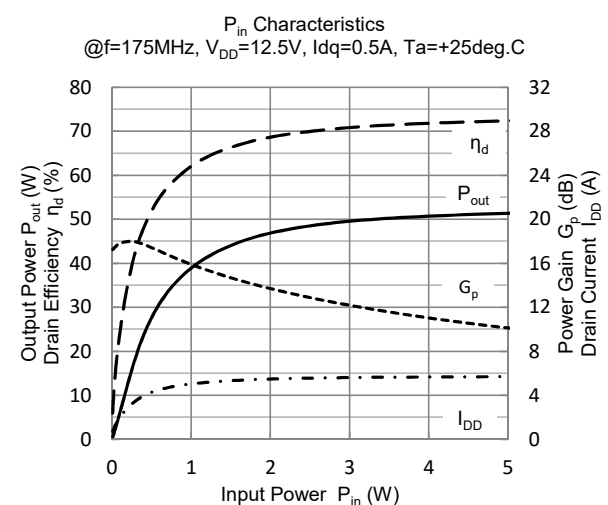
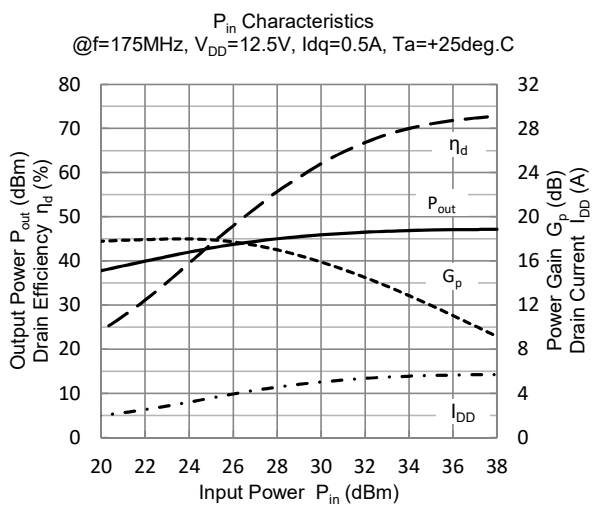
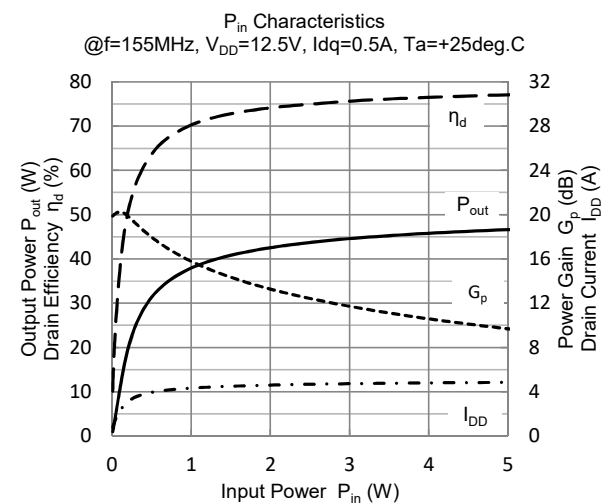
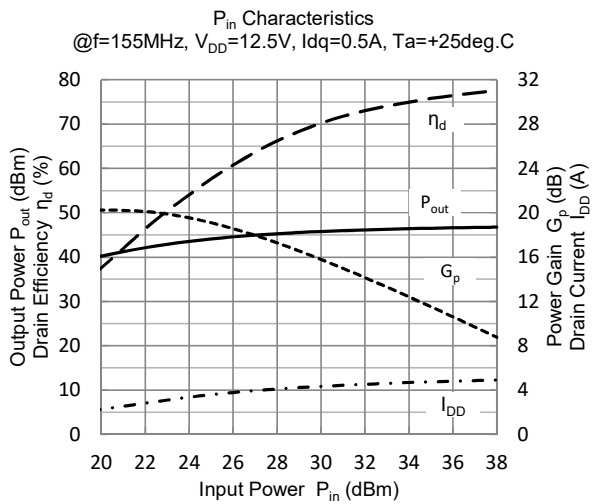
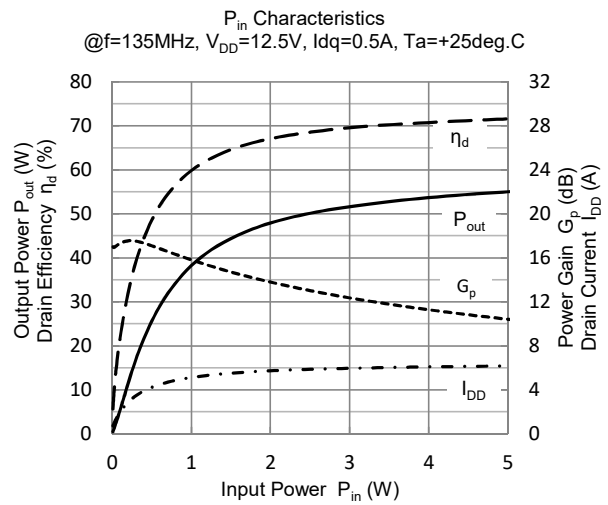
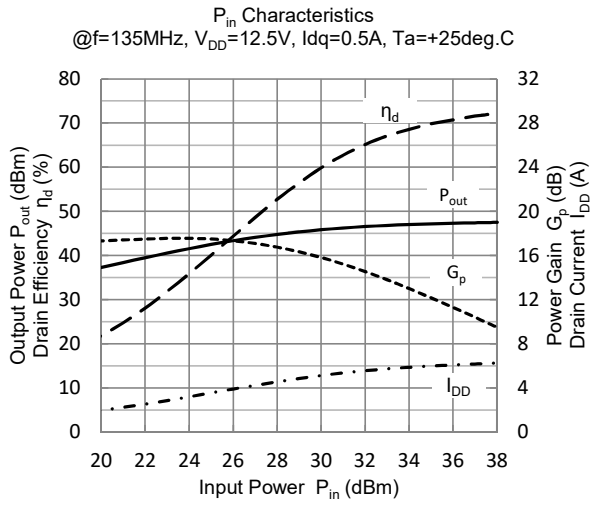

G2K-Si-221014-1

# RD35HUP2

RoHS Compliance, Silicon MOSFET Power Transistor, 175MHz, 530MHz, 35W, 12.5V

## TYPICAL RF CHARACTERISTICS of 450-530 MHz EVB ( Frequency vs $P_{out}$ , $\eta_d$ , $G_p$ )

(These are only typical curves and devices are not necessarily guaranteed at these curves.)

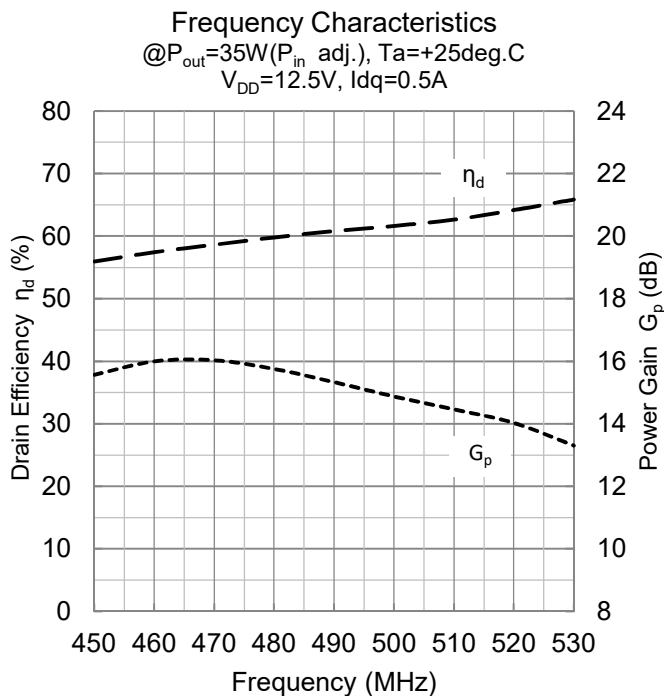
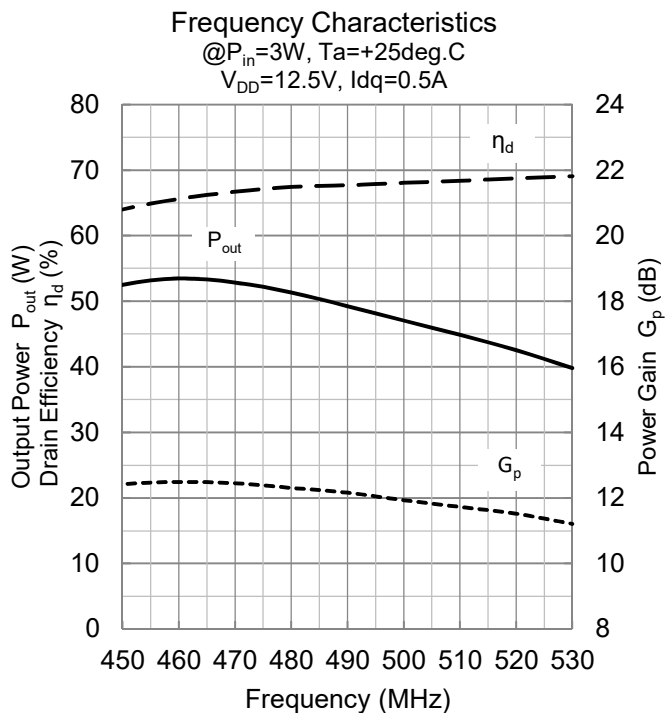

# RD35HUP2

RoHS Compliance, Silicon MOSFET Power Transistor, 175MHz, 530MHz, 35W, 12.5V

## TYPICAL RF CHARACTERISTICS of 450-530 MHz EVB ( $P_{out}$ vs $G_p$ , $\eta_d$ , $I_{DD}$ )

(These are only typical curves and devices are not necessarily guaranteed at these curves.)

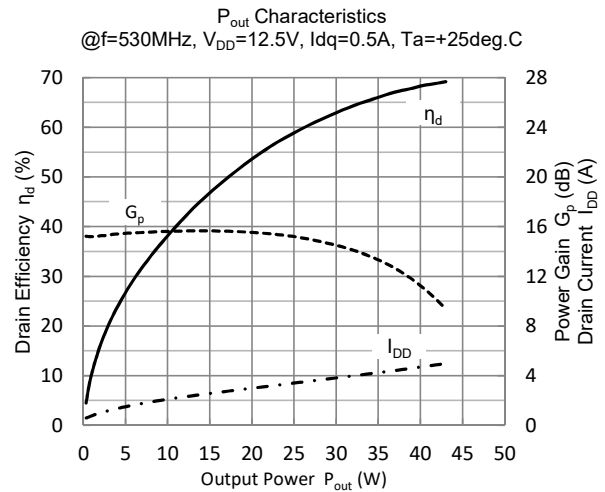
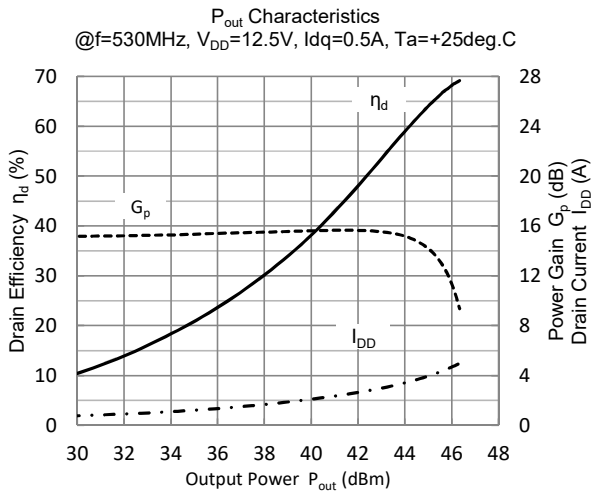
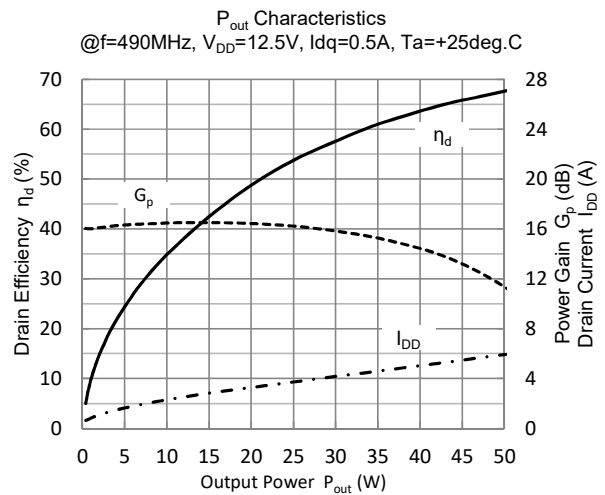
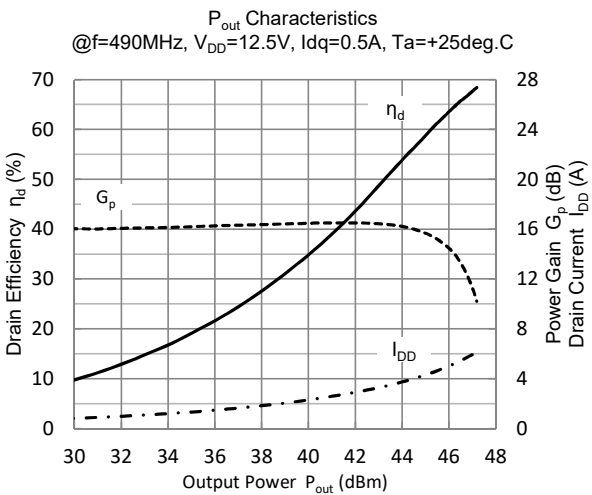
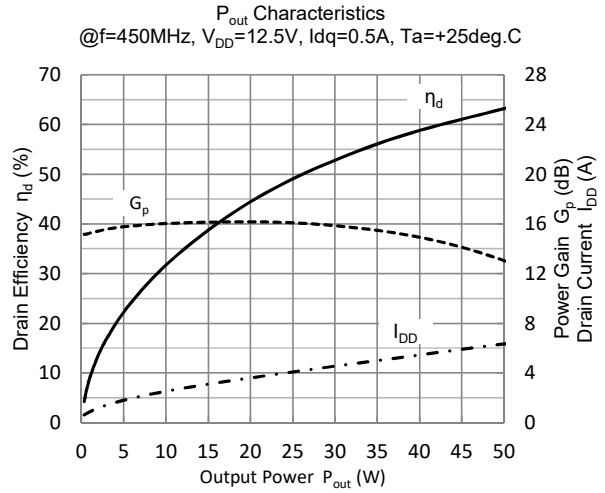
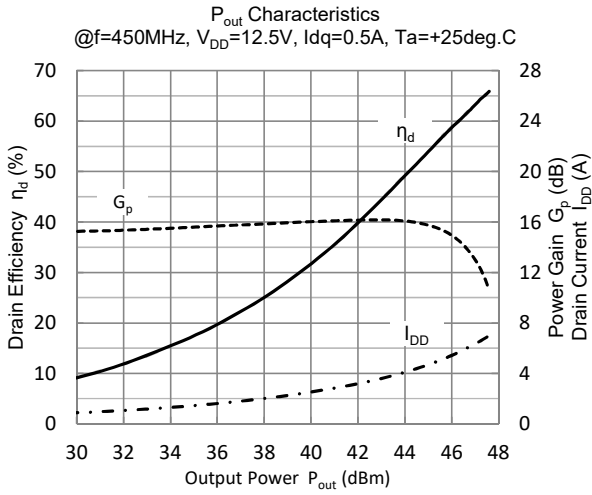

G2K-Si-221014-1



# RD35HUP2

RoHS Compliance, Silicon MOSFET Power Transistor, 175MHz, 530MHz, 35W, 12.5V

## TYPICAL RF CHARACTERISTICS of 450-530 MHz EVB ( $P_{in}$ vs $P_{out}$ $G_p$ , $\eta_d$ , $I_{DD}$ )

(These are only typical curves and devices are not necessarily guaranteed at these curves.)

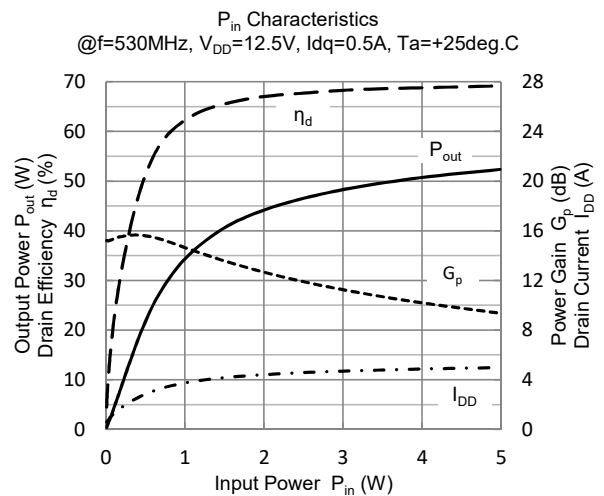
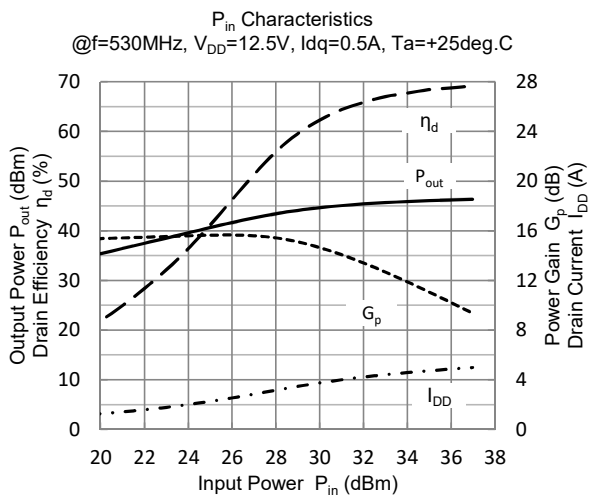
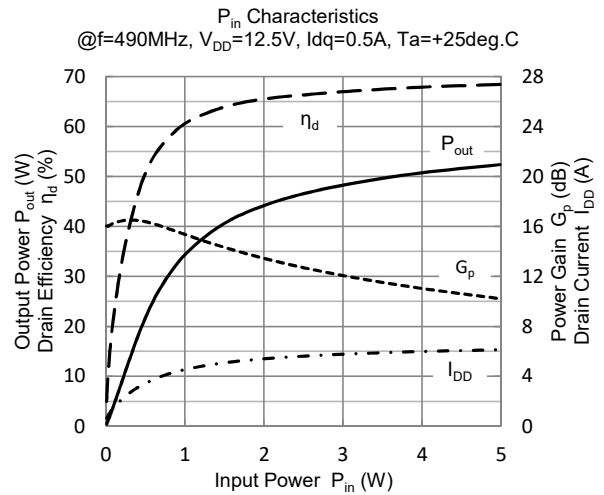
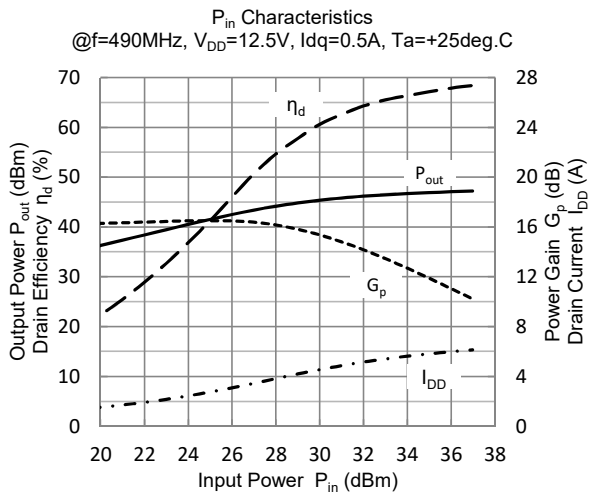
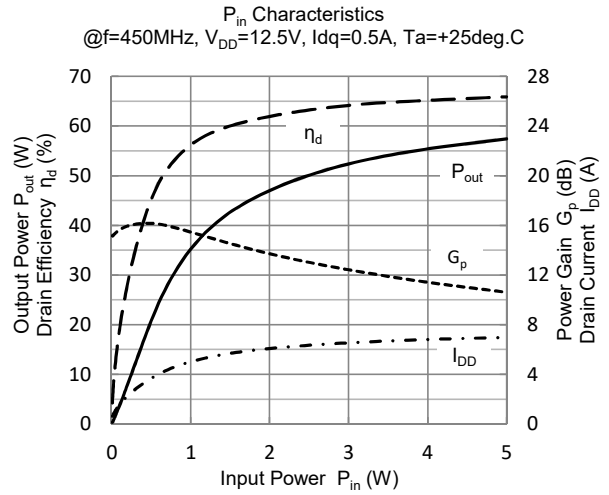
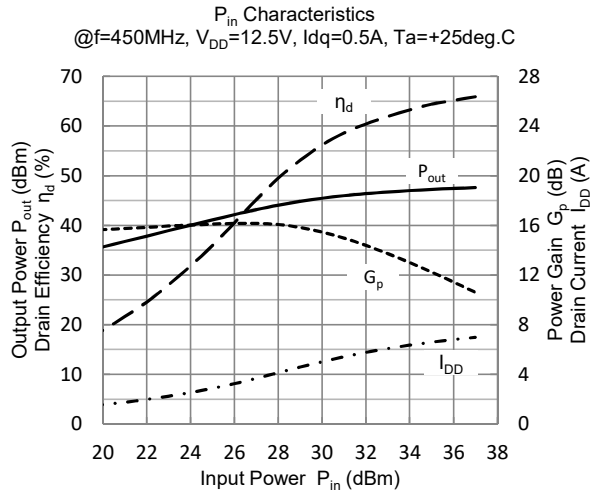

# RD35HUP2

RoHS Compliance, Silicon MOSFET Power Transistor, 175MHz, 530MHz, 35W, 12.5V

## TYPICAL RF CHARACTERISTICS of 380-470 MHz EVB ( $P_{out}$ vs ACP, $\eta_d$ , $G_p$ )

(These are only typical curves and devices are not necessarily guaranteed at these curves.)

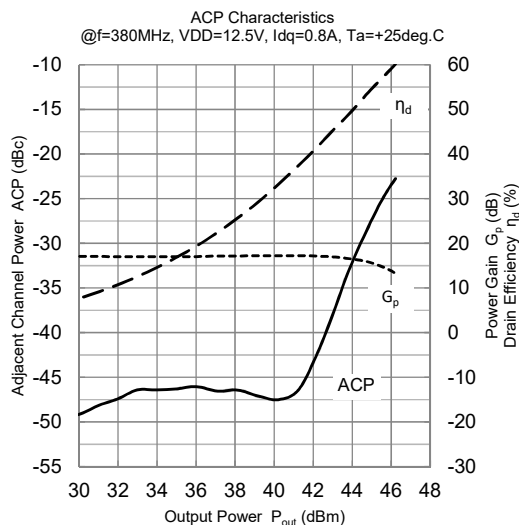

Modulation: TETRA

$\pi/4$ DQPSK, Root Nyquist Filter ( $\alpha=0.35$ ),

Symbol rate=18ksps,

Band Width=18kHz, Cannel Spacing=25KHz

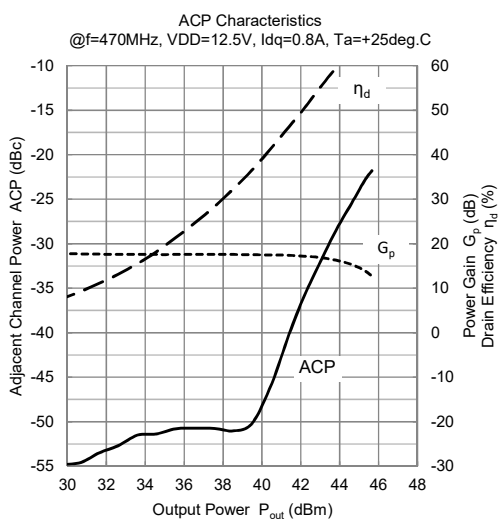
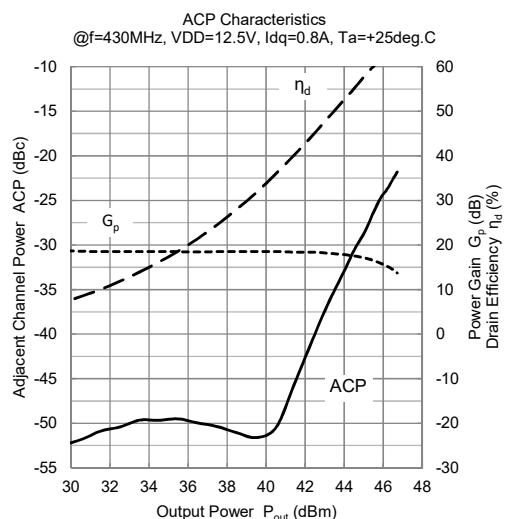

G2K-Si-221014-1



**RD35HUP2**

RoHS Compliance, Silicon MOSFET Power Transistor, 175MHz, 530MHz, 35W, 12.5V

**COMPONENT LIST**

Parts Type	No.	Description	P/N	Manufacturer
Capasitor	C1	43pF 2012 Hi-Q	GQM2195C2E430JB12	MURATA MANUFACTURING CO.
	C2	15pF 2012 Hi-Q	GQM2195C2E150JB12	MURATA MANUFACTURING CO.
	C3	43pF 2012 Hi-Q	GQM2195C2E430JB12	MURATA MANUFACTURING CO.
	C4	24pF 1608 Hi-Q	GQM1882C1H240JB01	MURATA MANUFACTURING CO.
	C5	15pF 1608 Hi-Q	GQM1882C1H150JB01	MURATA MANUFACTURING CO.
	C6	24pF 1608 Hi-Q	GQM1882C1H240JB01	MURATA MANUFACTURING CO.
	C7	100pF 2012 Hi-Q	GQM2195C2E101JB12	MURATA MANUFACTURING CO.
	C8	100pF 2012 Hi-Q	GQM2195C2E101JB12	MURATA MANUFACTURING CO.
	C9	30pF 2012 Hi-Q	GQM2195C2E300JB12	MURATA MANUFACTURING CO.
	C10	24pF 2012 Hi-Q	GQM2195C2E240JB12	MURATA MANUFACTURING CO.
	C11	100pF 2012 Hi-Q	GQM2195C2E101JB12	MURATA MANUFACTURING CO.
	C12	100pF 2012 Hi-Q	GQM2195C2E101JB12	MURATA MANUFACTURING CO.
	C13	100pF 2012 Hi-Q	GQM2195C2E101JB12	MURATA MANUFACTURING CO.
	C14	20pF 2012 Hi-Q	GQM2195C2E200JB12	MURATA MANUFACTURING CO.
	C15	36pF 2012 Hi-Q	GQM2195C2E360JB12	MURATA MANUFACTURING CO.
	C16	30pF 2012 Hi-Q	GQM2195C2E300JB12	MURATA MANUFACTURING CO.
	C17	24pF 2012 Hi-Q	GQM2195C2E240JB12	MURATA MANUFACTURING CO.
	C18	6.2pF 2012 Hi-Q	GQM2195C2E6R2DB12	MURATA MANUFACTURING CO.
	C19	390pF 3216	GRM31A5C2H391JW01	MURATA MANUFACTURING CO.
	C20	1000pF 2012	GRM216B11H102KA01	MURATA MANUFACTURING CO.
	C21	1000pF 2012	GRM216B11H102KA01	MURATA MANUFACTURING CO.
	C22	0.22μF 2012	GRM21BB31H224KA88	MURATA MANUFACTURING CO.
	C23	220μF -	EEUFC1V221	Panasonic Corporation
Register	R1	2.2Ω 2012	RPC10T2R2J	TAIYOSHA ELECTRIC CO.
	R2	4700Ω 1608	RPC05T472J	TAIYOSHA ELECTRIC CO.
Inductor	L1	39nH 1608	LQW18AN39NJ00	MURATA MANUFACTURING CO.
	L2	39nH 1608	LQW18AN39NJ00	MURATA MANUFACTURING CO.
	L3	13nH 1608	LQW18AN13NJ00	MURATA MANUFACTURING CO.
	L4	12nH Enameled wire 3Tums, Diameter:0.80mm, φ2.2mm(the out side diameter)	8003C	YC Corporation Co.,Ltd.
	L5	12nH Enameled wire 3Tums, Diameter:0.80mm, φ2.2mm(the out side diameter)	8003C	YC Corporation Co.,Ltd.
	L6	25nH Enameled wire 5Tums, Diameter:0.80mm, φ2.2mm(the out side diameter)	8005C	YC Corporation Co.,Ltd.

# RD35HUP2

RoHS Compliance, Silicon MOSFET Power Transistor, 175MHz, 530MHz, 35W, 12.5V

## Input / Output Impedance of 135-175 MHz EVB

$Z_{out}^*(f=135\text{MHz}, 155\text{MHz}, 175\text{MHz})$

$Z_o=10\text{ohm}$

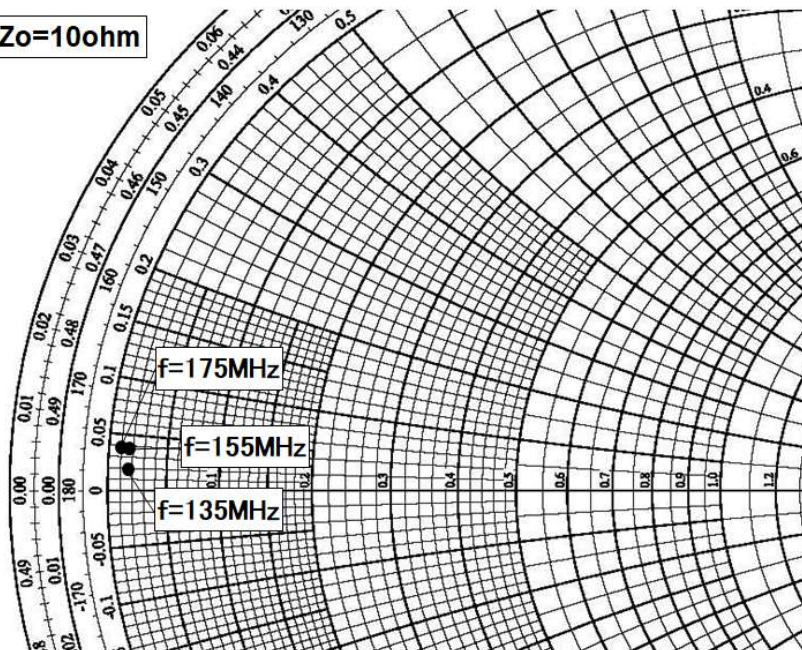

@ $P_{in}=3\text{W}$ ,  $V_{ds}=12.5\text{V}$ ,  
 $I_{dq}=0.5\text{A}$

f (MHz)	$Z_{out}^*$ (ohm)
135	0.27-j0.12
155	0.36-j0.15
175	0.24-j0.15

$Z_{out}^*$ : Complex conjugate of output impedance

$Z_{in}^*(f=135\text{MHz}, 155\text{MHz}, 175\text{MHz})$

$Z_o=10\text{ohm}$

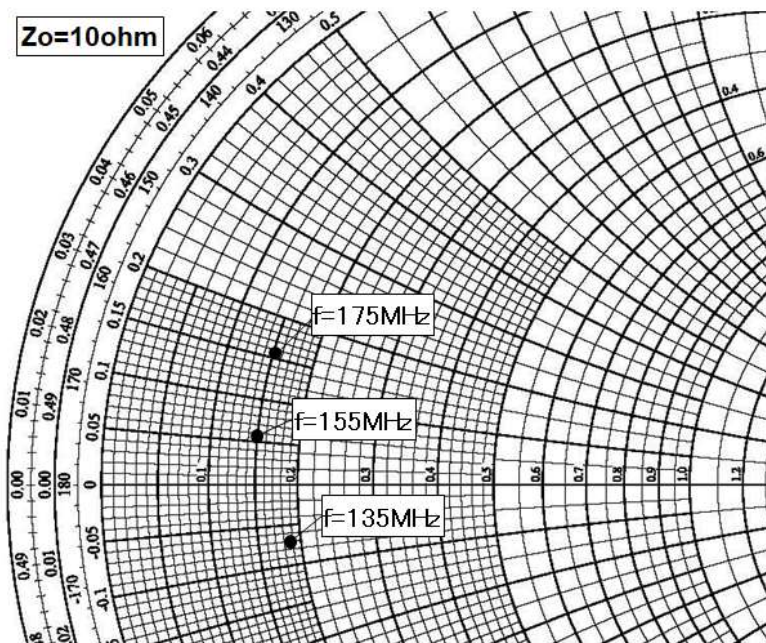

@ $P_{in}=3\text{W}$ ,  $V_{ds}=12.5\text{V}$ ,  
 $I_{dq}=0.5\text{A}$

f (MHz)	$Z_{in}^*$ (ohm)
135	1.85-j0.80
155	1.51+j0.56
175	1.52+j1.55

$Z_{in}^*$ : Complex conjugate of input impedance

# RD35HUP2

RoHS Compliance, Silicon MOSFET Power Transistor, 175MHz, 530MHz, 35W, 12.5V

## EQUIVALENT CIRCUITRY for UHF Circuit of f=450-530MHz

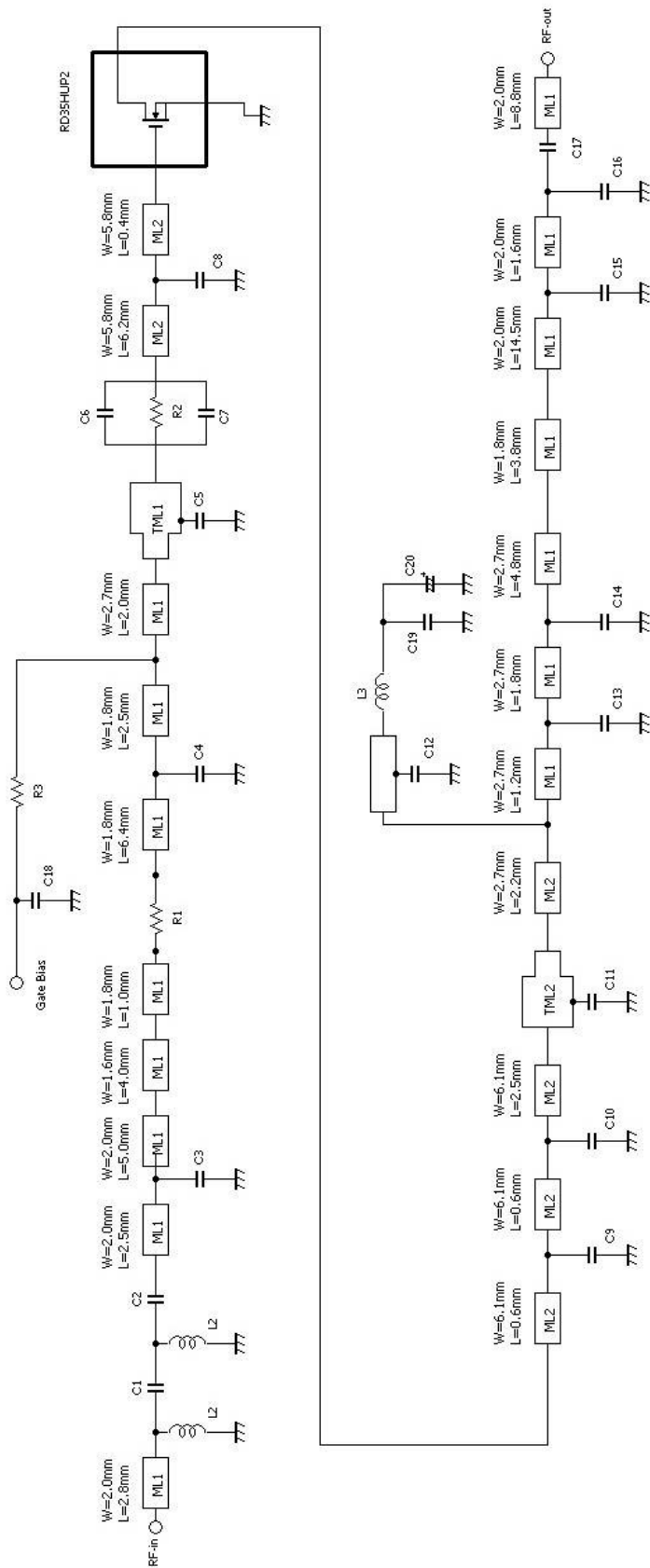

Note:  
 Evaluation board materials  
 Glass-Epoxy substrate ( $E_r=4.8, t=1.6\text{mm}, \tan D=0.015@1.0\text{GHz}$ )

Micro strip line substrate thickness

ML1, TML1:  $t=1.3\text{mm}$   
 ML2, TML2:  $t=0.2\text{mm}$

Via hole diameters  
 Diameter=0.8mm, Length=1.5mm

**RD35HUP2**

RoHS Compliance, Silicon MOSFET Power Transistor, 175MHz, 530MHz, 35W, 12.5V

**COMPONENT LIST**

Parts Type	Symbol	Description	Type name	Vender
Capasitor	C 1	6.8 pF 2012 Hi-Q	GQM2195C2E6R8DB12	Murata Manufacturing Co.,Ltd
	C 2	16 pF 2012 Hi-Q	GQM2195C2E160JB12	Murata Manufacturing Co.,Ltd
	C 3	8.2 pF 1608 Hi-Q	GQM1882C1H8R2DB01	Murata Manufacturing Co.,Ltd
	C 4	6.2 pF 1608 Hi-Q	GQM1882C2A6R2DB01	Murata Manufacturing Co.,Ltd
	C 5	33 pF 1608 Hi-Q	GQM1882C1H330JB01	Murata Manufacturing Co.,Ltd
	C 6	130 pF 2012	GRM2162C2A131JA01	Murata Manufacturing Co.,Ltd
	C 7	130 pF 2012	GRM2162C2A131JA01	Murata Manufacturing Co.,Ltd
	C 8	51 pF 1608 Hi-Q	GQM1882C1H510JB01	Murata Manufacturing Co.,Ltd
	C 9	30 pF 2012 Hi-Q	GQM2195C2E300JB12	Murata Manufacturing Co.,Ltd
	C 10	33 pF 2012 Hi-Q	GQM2195C2E330JB12	Murata Manufacturing Co.,Ltd
	C 11	5.1 pF 2012 Hi-Q	GQM2195C2E5R1DB12	Murata Manufacturing Co.,Ltd
	C 12	2.7 pF 2012 Hi-Q	GQM2195C2E2R7CB12	Murata Manufacturing Co.,Ltd
	C 13	10 pF 2012 Hi-Q	GQM2195C2E100JB12	Murata Manufacturing Co.,Ltd
	C 14	10 pF 2012 Hi-Q	GQM2195C2E100JB12	Murata Manufacturing Co.,Ltd
	C 15	4.7 pF 2012 Hi-Q	GQM2195C2E4R7CB12	Murata Manufacturing Co.,Ltd
	C 16	4.7 pF 2012 Hi-Q	GQM2195C2E4R7CB12	Murata Manufacturing Co.,Ltd
	C 17	62 pF 2012 Hi-Q	GQM2195C2E620JB12	Murata Manufacturing Co.,Ltd
	C 18	1000 pF 1608	GRM188R61H102KA01	Murata Manufacturing Co.,Ltd
	C 19	100000 pF 2012	GRM21BB11H104KA01	Murata Manufacturing Co.,Ltd
	C 20	220 μF	EEUFC1V221	Panasonic Corporation
Register	R 1	0 Ω	RPC05T0R0J	Taiyosha Electric Co.,Ltd
	R 2	2.2 Ω	RPC10T2R2J	Taiyosha Electric Co.,Ltd
	R 3	2.2 kΩ	RPC05T222J	Taiyosha Electric Co.,Ltd
Inductor	L 1	39 nH 1608	LQW18AN39NJ00	Murata Manufacturing Co.,Ltd
	L 2	18 nH 1608	LQW18AN18NJ10	Murata Manufacturing Co.,Ltd
	L 3	17nH Enameled wire 4Turns, Diameter,0.8mm, φ2.2mm(inside diameter)	8004C	YC Corporation Co.,Ltd

# RD35HUP2

RoHS Compliance, Silicon MOSFET Power Transistor, 175MHz, 530MHz, 35W, 12.5V

---

## Recommended device usage as power amplifier

(1) Mitsubishi recommends a structure mounted like Figure 1 for this device used in the power amplifier.

Please fix the source of device backside directly on heat sink by solder.

(If heat dissipation is insufficient, there is a possibility that the destruction caused by heat is generated.)

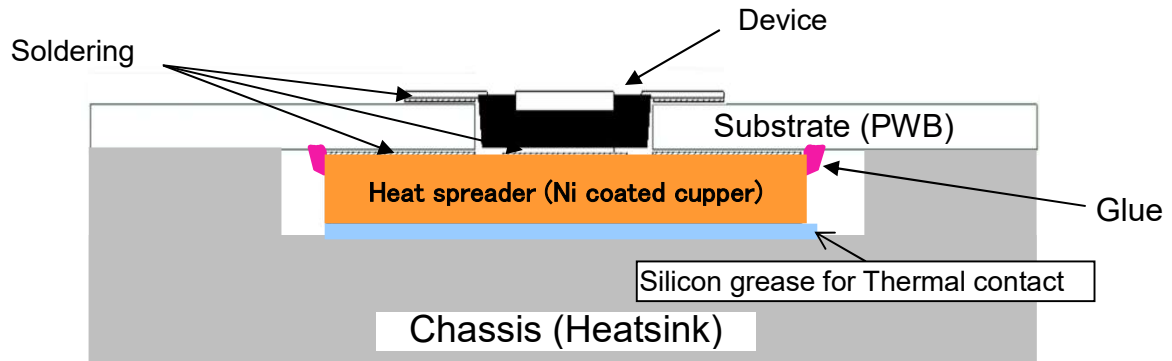

**Fig.1**



# RD35HUP2

RoHS Compliance, Silicon MOSFET Power Transistor, 175MHz, 530MHz, 35W, 12.5V

---

## ATTENTION:

- 1.High Temperature ; This product might have a heat generation while operation,Please take notice that have a possibility to receive a burn to touch the operating product directly or touch the product until cold after switch off. At the near the product,do not place the combustible material that have possibilities to arise the fire
- 2.Generation of High Frequency Power ; This product generate a high frequency power. Please take notice that do not leakage the unnecessary electric wave and use this products without cause damage for human and property per normal operation.
- 3.Before use; Before use the product,Please design the equipment in consideration of the risk for human and electric wave obstacle for equipment.

## PRECAUTIONS FOR THE USE OF MITSUBISHI SILICON RF POWER DEVICES:

1. The specifications of mention are not guarantee values in this data sheet. Please confirm additional details regarding operation of these products from the formal specification sheet. For copies of the formal specification sheets, please contact one of our sales offices.
- 2.RA series products (RF power amplifier modules) and RD series products (RF power transistors) are designed for consumer mobile communication terminals and were not specifically designed for use in other applications.  
In particular, while these products are highly reliable for their designed purpose, they are not manufactured under a quality assurance testing protocol that is sufficient to guarantee the level of reliability typically deemed necessary for critical communications elements and In the application, which is base station applications and fixed station applications that operate with long term continuous transmission and a higher on-off frequency during transmitting, please consider the derating, the redundancy system, appropriate setting of the maintain period and others as needed. For the reliability report which is described about predicted operating life time of Mitsubishi Silicon RF Products , please contact Mitsubishi Electric Corporation or an authorized Mitsubishi Semiconductor product distributor.
3. RD series products use MOSFET semiconductor technology. They are sensitive to ESD voltage therefore appropriate ESD precautions are required.
4. In the case of use in below than recommended frequency, there is possibility to occur that the device is deteriorated or destroyed due to the RF-swing exceed the breakdown voltage.
5. In order to maximize reliability of the equipment, it is better to keep the devices temperature low. It is recommended to utilize a sufficient sized heat-sink in conjunction with other cooling methods as needed (fan, etc.) to keep the channel temperature for RD series products lower than 120deg/C(in case of Tchmax=150deg/C) ,140deg/C(in case of Tchmax=175deg/C) under standard conditions.
6. Do not use the device at the exceeded the maximum rating condition. In case of plastic molded devices, the exceeded maximum rating condition may cause blowout, smoldering or catch fire of the molding resin due to extreme short current flow between the drain and the source of the device. These results causes in fire or injury.
7. For specific precautions regarding assembly of these products into the equipment, please refer to the supplementary items in the specification sheet.
8. Warranty for the product is void if the products protective cap (lid) is removed or if the product is modified in any way from it's original form.
9. For additional "Safety first" in your circuit design and notes regarding the materials, please refer the last page of this data sheet.

< Silicon RF Power MOS FET (Discrete) >

# RD35HUP2

**RoHS Compliance, Silicon MOSFET Power Transistor, 175MHz, 530MHz, 35W, 12.5V**

---

10. Please avoid use in the place where water or organic solvents can adhere directly to the product and the environments with the possibility of caustic gas, dust, salinity, etc. Reliability could be markedly decreased and also there is a possibility failures could result causing a serious accident. Likewise, there is a possibility of causing a serious accident if used in an explosive gas environment. Please allow for adequate safety margin in your designs.

11. Please refer to the additional precautions in the formal specification sheet.

# RD35HUP2

RoHS Compliance, Silicon MOSFET Power Transistor, 175MHz, 530MHz, 35W, 12.5V

## **Keep safety first in your circuit designs!**

Mitsubishi Electric Corporation puts the maximum effort into making semiconductor products better and more reliable, but there is always the possibility that trouble may occur with them. Trouble with semiconductors may lead to personal injury, fire or property damage. Remember to give due consideration to safety when making your circuit designs, with appropriate measures such as (i) placement of substitutive, auxiliary circuits, (ii) use of non-flammable material or (iii) prevention against any malfunction or mishap.

## **Notes regarding these materials**

- These materials are intended as a reference to assist our customers in the selection of the Mitsubishi Electric Semiconductor product best suited to the customer's application; they do not convey any license under any intellectual property rights, or any other rights, belonging to Mitsubishi Electric Corporation or a third party.
- Mitsubishi Electric Corporation assumes no responsibility for any damage, or infringement of any third-party's rights, originating in the use of any product data, diagrams, charts, programs, algorithms, or circuit application examples contained in these materials.
- All information contained in these materials, including product data, diagrams, charts, programs and algorithms represents information on products at the time of publication of these materials, and are subject to change by Mitsubishi Electric Corporation without notice due to product improvements or other reasons. It is therefore recommended that customers contact Mitsubishi Electric Corporation or an authorized Mitsubishi Electric Semiconductor product distributor for the latest product information before purchasing a product listed herein. The information described here may contain technical inaccuracies or typographical errors. Mitsubishi Electric Corporation assumes no responsibility for any damage, liability, or other loss rising from these inaccuracies or errors.  
Please also pay attention to information published by Mitsubishi Electric Corporation by various means, including the Mitsubishi Electric Semiconductor home page (<http://www.MitsubishiElectric.com/semiconductor/>).
- When using any or all of the information contained in these materials, including product data, diagrams, charts, programs, and algorithms, please be sure to evaluate all information as a total system before making a final decision on the applicability of the information and products. Mitsubishi Electric Corporation assumes no responsibility for any damage, liability or other loss resulting from the information contained herein.
- Mitsubishi Electric Corporation semiconductors are not designed or manufactured for use in a device or system that is used under circumstances in which human life is potentially at stake. Please contact Mitsubishi Electric Corporation or an authorized Mitsubishi Electric Semiconductor product distributor when considering the use of a product contained herein for any specific purposes, such as apparatus or systems for transportation, vehicular, medical, aerospace, nuclear, or undersea repeater use.
- The prior written approval of Mitsubishi Electric Corporation is necessary to reprint or reproduce in whole or in part these materials.
- If these products or technologies are subject to the Japanese export control restrictions, they must be exported under a license from the Japanese government and cannot be imported into a country other than the approved destination.  
Any diversion or re-export contrary to the export control laws and regulations of Japan and/or the country of destination is prohibited.
- Please contact Mitsubishi Electric Corporation or an authorized Mitsubishi Electric Semiconductor product distributor for further details on these materials or the products contained therein.