

Thyristor Modules Thyristor/Diode Modules

PSKT 250
PSKH 250

$I_{TRMS} = 2x 450 A$
 $I_{TAVM} = 2x 287 A$
 $V_{RRM} = 800-1800 V$

Preliminary Data Sheet

V_{RSM}	V_{RRM}	Type	
V_{DSM}	V_{DRM}	Version 1	
V	V	Version 1	Version 1
900	800	PSKT 250/08io1	PSKH 250/08io1
1300	1200	PSKT 250/12io1	PSKH 250/12io1
1500	1400	PSKT 250/14io1	PSKH 250/14io1
1700	1600	PSKT 250/16io1	PSKH 250/16io1
1900	1800	PSKT 250/18io1	PSKH 250/18io1



Symbol	Test Conditions	Maximum Ratings	
I_{TRMS}, I_{FRMS}	$T_{VJ} = T_{VJM}$ $T_C = 85^\circ C; 180^\circ$ sine	450	A
I_{TAVM}, I_{FAVM}		287	A
I_{TSM}, I_{FSM}	$T_{VJ} = 45^\circ C;$ $V_R = 0$	$t = 10$ ms (50 Hz), sine $t = 8.3$ ms (60 Hz), sine	9000 9600 A
	$T_{VJ} = T_{VJM}$ $V_R = 0$	$t = 10$ ms (50 Hz), sine $t = 8.3$ ms (60 Hz), sine	7800 8500 A
$\int i^2 dt$	$T_{VJ} = 45^\circ C$ $V_R = 0$	$t = 10$ ms (50 Hz), sine $t = 8.3$ ms (60 Hz), sine	405 000 380 000 A ² s
	$T_{VJ} = T_{VJM}$ $V_R = 0$	$t = 10$ ms (50 Hz), sine $t = 8.3$ ms (60 Hz), sine	304 000 300 000 A ² s
$(di/dt)_{cr}$	$T_{VJ} = T_{VJM}$ $f = 50$ Hz, $t_p = 200$ μ s $V_D = 2/3 V_{DRM}$ $I_G = 1$ A $di_G/dt = 1$ A/ μ s	repetitive, $I_T = 860$ A non repetitive, $I_T = 290$ A	100 800 A/ μ s
$(dv/dt)_{cr}$	$T_{VJ} = T_{VJM}$ $R_{GK} = \infty$; method 1 (linear voltage rise)	$V_{DR} = 2/3 V_{DRM}$	1000 V/ μ s
P_{GM}	$T_{VJ} = T_{VJM}$ $I_T = I_{TAVM}$	$t_p = 30$ μ s $t_p = 500$ μ s	120 60 W
P_{GAV}			20 W
V_{RGM}			10 V
T_{VJ}			-40...+140 $^\circ C$
T_{VJM}			140 $^\circ C$
T_{stg}			-40...+125 $^\circ C$
V_{ISOL}	50/60 Hz, RMS $I_{ISOL} \leq 1$ mA	$t = 1$ min $t = 1$ s	3000 3600 V~
M_d	Mounting torque (M5) Terminal connection torque (M8)		2.5-5/22-44 Nm/lb.in. 12-15/106-132 Nm/lb.in.
Weight	Typical including screws		320 g

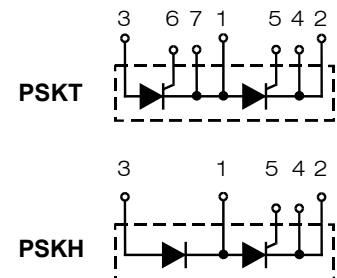

Features

- International standard package
- Direct copper bonded Al_2O_3 -ceramic base plate
- Planar passivated chips
- Isolation voltage 3600 V~
- UL registered, E 148688
- Keyed gate/cathode twin pins

Applications

- Motor control
- Power converter
- Heat and temperature control for industrial furnaces and chemical processes
- Lighting control
- Contactless switches

Advantages

- Space and weight savings
- Simple mounting with two screws
- Improved temperature and power cycling capability
- Reduced protection circuits

Data according to IEC 60747 and refer to a single thyristor/diode unless otherwise stated.

Symbol	Test Conditions	Characteristic Values
I_{RRM}	$T_{VJ} = T_{VJM}; V_R = V_{RRM}; V_D = V_{DRM}$	70 mA
I_{DRM}		40 mA
V_T, V_F	$I_T, I_F = 600 \text{ A}; T_{VJ} = 25^\circ\text{C}$	1.36 V
V_{T0}	For power-loss calculations only ($T_{VJ} = 140^\circ\text{C}$)	0.85 V
r_T		0.82 mΩ
V_{GT}	$V_D = 6 \text{ V}; T_{VJ} = 25^\circ\text{C}$	2 V
	$T_{VJ} = -40^\circ\text{C}$	3 V
I_{GT}	$V_D = 6 \text{ V}; T_{VJ} = 25^\circ\text{C}$	150 mA
	$T_{VJ} = -40^\circ\text{C}$	200 mA
V_{GD}	$T_{VJ} = T_{VJM}; V_D = 2/3 V_{DRM}$	0.25 V
I_{GD}		10 mA
I_L	$T_{VJ} = 25^\circ\text{C}; t_p = 30 \mu\text{s}; V_D = 6 \text{ V}$ $I_G = 0.45 \text{ A}; di_G/dt = 0.45 \text{ A}/\mu\text{s}$	200 mA
I_H	$T_{VJ} = 25^\circ\text{C}; V_D = 6 \text{ V}; R_{GK} = \infty$	150 mA
t_{gd}	$T_{VJ} = 25^\circ\text{C}; V_D = 1/2 V_{DRM}$ $I_G = 1 \text{ A}; di_G/dt = 1 \text{ A}/\mu\text{s}$	2 μs
t_q	$T_{VJ} = T_{VJM}; I_T = 300 \text{ A}; t_p = 200 \mu\text{s}; -di/dt = 10 \text{ A}/\mu\text{s}$ typ. $V_R = 100 \text{ V}; dv/dt = 50 \text{ V}/\mu\text{s}; V_D = 2/3 V_{DRM}$	200 μs
Q_S	$T_{VJ} = 125^\circ\text{C}; I_T, I_F = 400 \text{ A}; -di/dt = 50 \text{ A}/\mu\text{s}$	760 μC
I_{RM}		275 A
R_{thJC}	per thyristor/diode; DC current per module	0.129 K/W
R_{thJK}	per thyristor/diode; DC current per module	0.169 K/W
	other values see Fig. 8/9	0.0645 K/W
		0.0845 K/W
d_S	Creepage distance on surface	12.7 mm
d_A	Strike distance through air	9.6 mm
a	Maximum allowable acceleration	50 m/s ²

Optional accessories for modules

Keyed gate/cathode twin plugs with wire length = 350 mm, gate = yellow, cathode = red

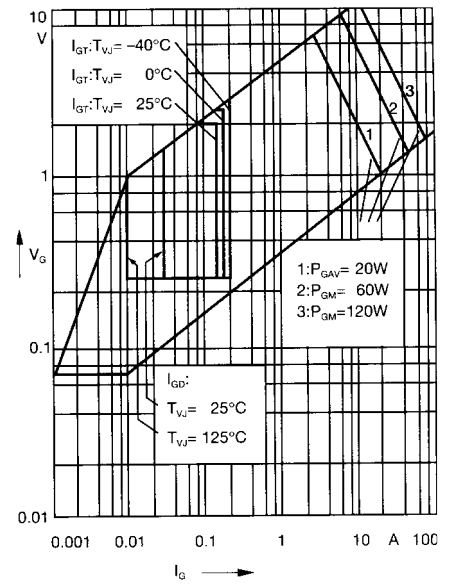

Fig. 1 Gate trigger characteristics

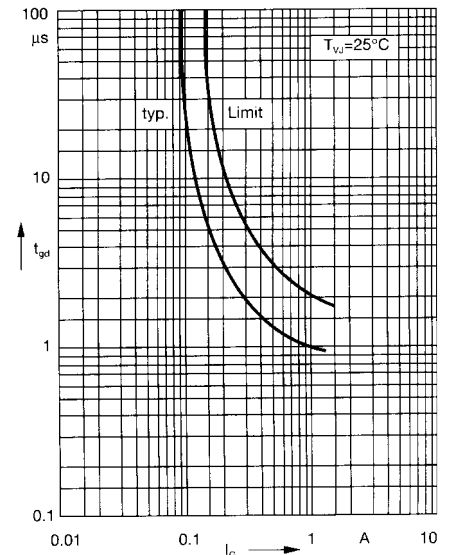
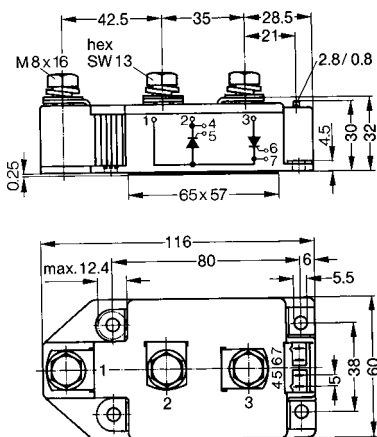

Fig. 2 Gate trigger delay time

Dimensions in mm (1 mm = 0.0394")

PSKT



PSKH

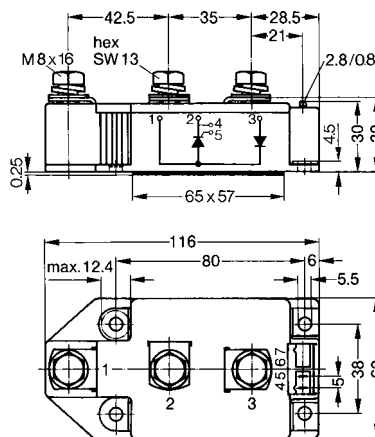

Threaded spacer for higher Anode/Cathode construction:
Type ZY 250, material brass

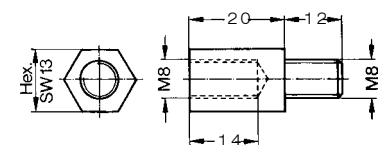

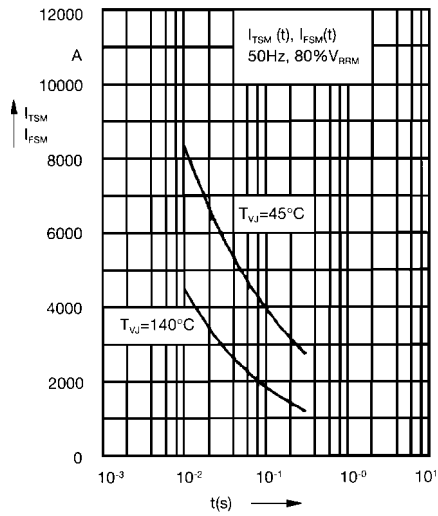

Fig. 3 Surge overload current
 I_{TSM} , I_{FSM} : Crest value, t : duration

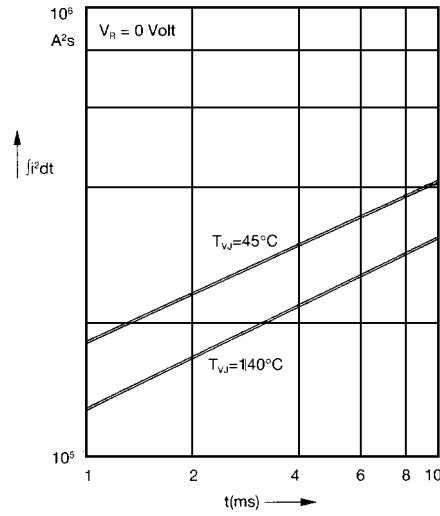

Fig. 4 $\int i^2 dt$ versus time (1-10 ms)

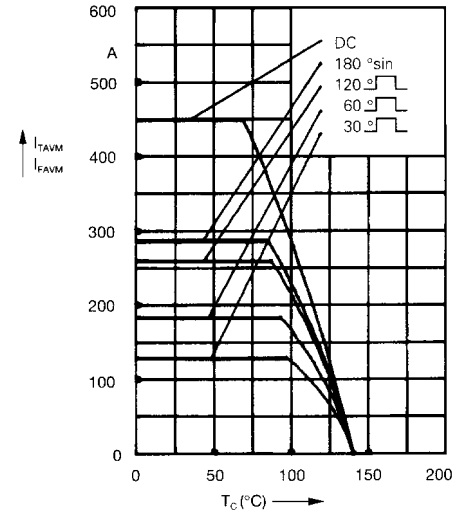

Fig. 4a Maximum forward current at case temperature

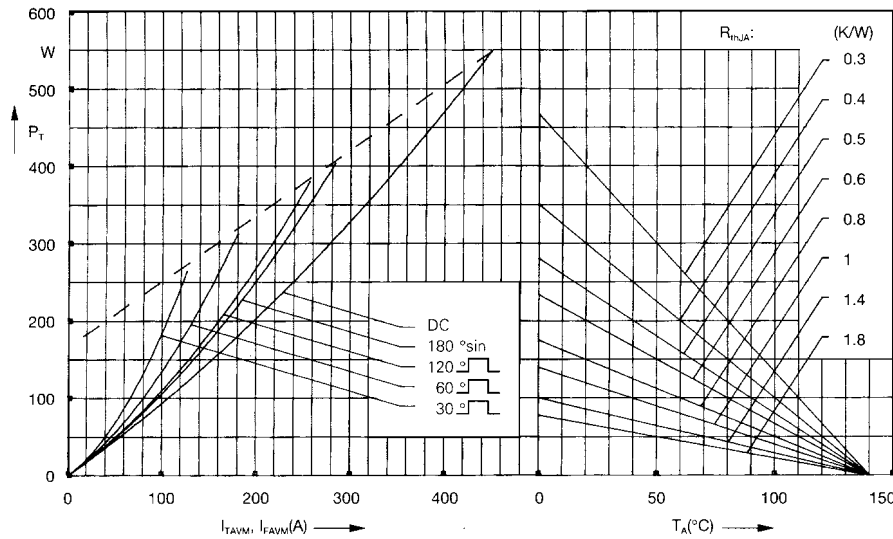

Fig. 5 Power dissipation versus on-state current and ambient temperature (per thyristor or diode)

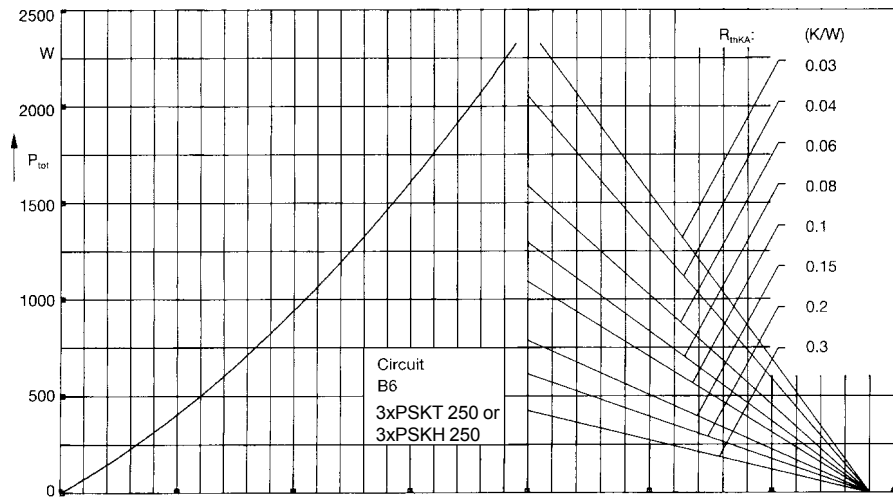

Fig. 6 Three phase rectifier bridge: Power dissipation versus direct output current and ambient temperature

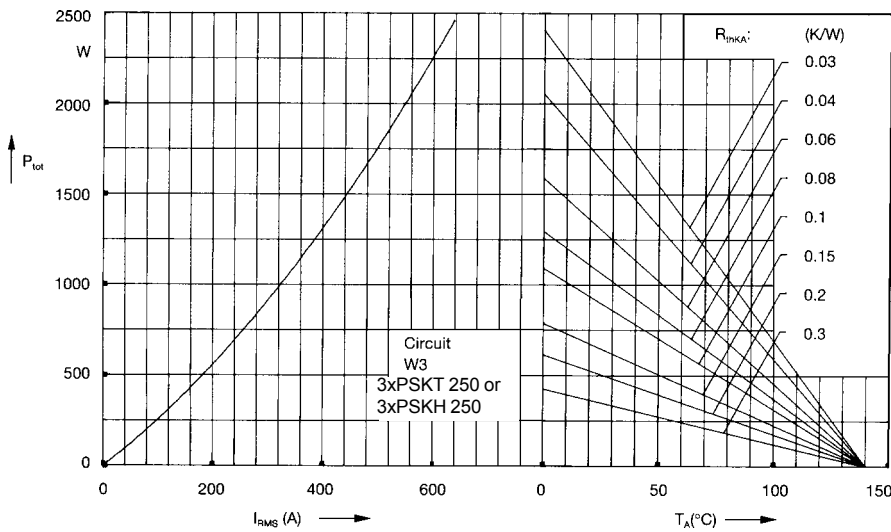

Fig. 7 Three phase AC-controller: Power dissipation versus RMS output current and ambient temperature

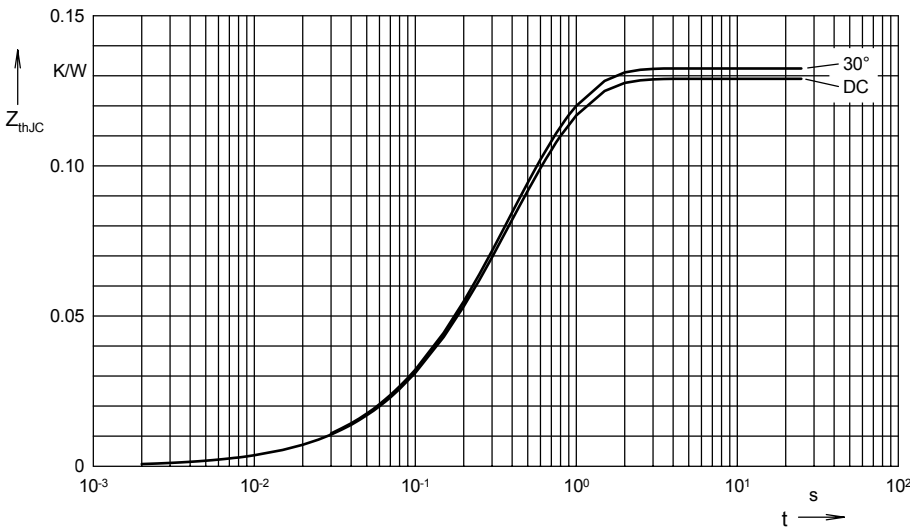

Fig. 8 Transient thermal impedance junction to case (per thyristor or diode)

R_{thJC} for various conduction angles d :

d	R_{thJC} (K/W)
DC	0.129
180°	0.131
120°	0.131
60°	0.132
30°	0.132

Constants for Z_{thJC} calculation:

i	R_{thi} (K/W)	t_i (s)
1	0.0035	0.099
2	0.0165	0.168
3	0.1091	0.456

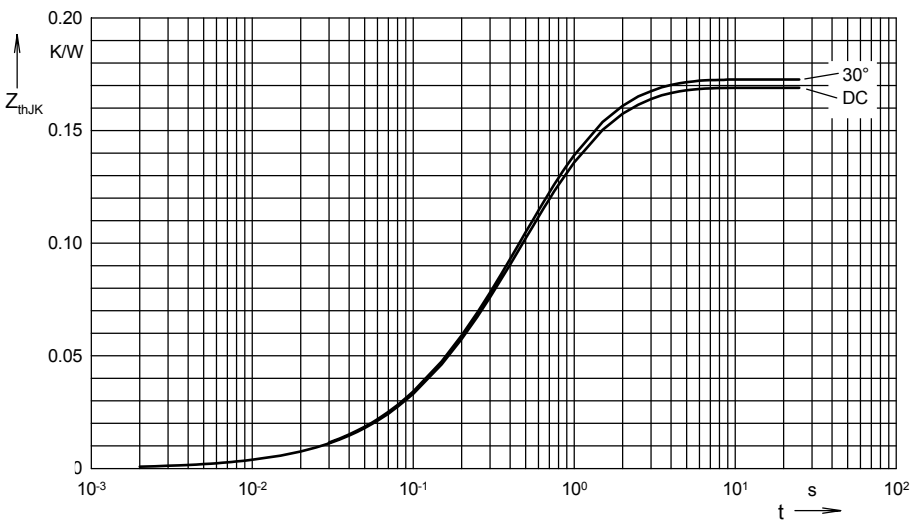

Fig. 9 Transient thermal impedance junction to heatsink (per thyristor or diode)

R_{thJK} for various conduction angles d :

d	R_{thJK} (K/W)
DC	0.169
180°	0.171
120°	0.172
60°	0.172
30°	0.173

Constants for Z_{thJK} calculation:

i	R_{thi} (K/W)	t_i (s)
1	0.0033	0.099
2	0.0159	0.168
3	0.1053	0.456
4	0.04	1.36