

OD8025 Series

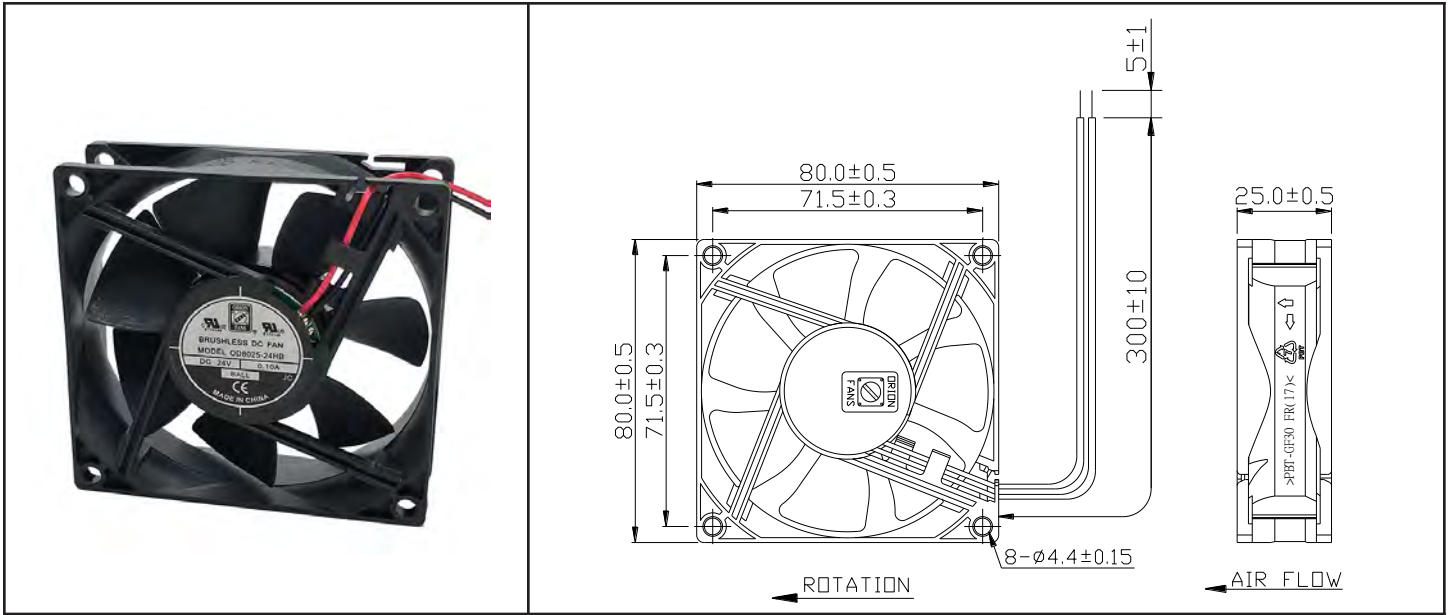

DC Fan - 12, 24V
80x25mm (3.15"x 1.0")



Frame & Impeller	PBT, UL94V-0 plastic	Available Options: Tachometer (FG) Alarm (RD) Thermal Speed Control PWM Input Sleeve bearing IP55 48V Life Expectancy (L10) 65,000 hours (45C) Weight: ~ 0.19 lbs m1	
Connection	2x Lead wires 24AWG		
Motor	Brushless DC, auto restart, polarity protected		
Bearing System	Dual ball bearing		
Insulation Resistance	10M ohm between leadwire and frame (500VDC)		
Dielectric Strength	1 minute at 500 VAC, max leakage < 500 MicroAmp		
Temperature Range	-20C ~ +75C		
Storage Temperature	-40C ~ +80C		

Model Number	Speed (RPM)	Airflow (CFM)	Noise (dB)	Volts DC	Input Power (Watts)	Amps	Max. Static Pressure (\"H ₂ O)
OD8025-12HHB	3400	44	40	12	2.16	0.23	0.19
OD8025-12HB	3100	40	35	12	1.8	0.18	0.15
OD8025-12MB	2500	31	28	12	0.96	0.13	0.10
OD8025-12LB	2100	26	23	12	0.60	0.09	0.07
OD8025-12LLB	1600	19	15	12	0.49	0.04	0.04
OD8025-24HB	3100	40	35	24	1.44	0.10	0.16
OD8025-24MB	2500	31	28	24	0.96	0.06	0.10
OD8025-24LB	2100	26	23	24	0.72	0.05	0.07

To indicate sleeve bearing replace "B" suffix with "S" in part number (30,000 hrs life expectancy)
 To indicate sealed sleeve bearing replace "B" with "SS" in part number (50,000 hrs life expectancy)