

1MBI1000VXB-170EL-50

IGBT Modules

IGBT MODULE (V series) 1700V / 1000A / 1 in one package

■ Features

- High speed switching
- Voltage drive
- Low Inductance module structure

■ Applications

- NPC 3-level Inverter
- Inverter DB for Motor Drive
- AC and DC Servo Drive Amplifier (DB)
- Active PFC
- Industrial machines



■ Maximum Ratings and Characteristics

● Absolute Maximum Ratings (at T_c=25°C unless otherwise specified)

Items	Symbols	Conditions	Maximum ratings	Units	
Collector-Emitter voltage	V _{CES}		1700	V	
Gate-Emitter voltage	V _{GES}		±20	V	
Collector current	I _c	Continuous	T _c =25°C 1400 T _c =100°C 1000	A	
	I _c pulse	1ms	2000		
	-I _c		1000		
	-I _c pulse	1ms	2000		
Collector Power Dissipation	P _c	1 device	6250	W	
Reverse voltage for FWD	V _R		1700	V	
Forward current for FWD	I _F	Continuous	1000	A	
	I _F pulse	1ms	2000		
Junction temperature	T _j		175	°C	
Operating junction temperature (under switching conditions)	T _{top}		150		
Case temperature	T _c		150		
Storage temperature	T _{stg}		-40 ~ +150		
Isolation voltage	between terminal and copper base (*1)	V _{iso}	AC : 1min.	4000	VAC
	between thermistor and others (*2)				
Screw Torque (*3)	Mounting	-	M5	6.0	N m
	Main Terminals	-	M8	10.0	
	Sense Terminals	-	M4	2.1	

Note *1: All terminals should be connected together during the test.

Note *2: Two thermistor terminals should be connected together, other terminals should be connected together and shorted to base plate during the test.

Note *3: Recommendable Value : Mounting 3.0 ~ 6.0 Nm (M5)
 Recommendable Value : Main Terminals 8.0 ~ 10.0 Nm (M8)
 Recommendable Value : Sense Terminals 1.8 ~ 2.1 Nm (M4)

● Electrical characteristics (at T_J = 25°C unless otherwise specified)

Items	Symbols	Conditions	Characteristics			Units		
			min.	typ.	max.			
IGBT+Inverse Diode	Zero gate voltage collector current	I _{CEs}	V _{CE} = 1700V V _{GE} = 0V	-	-	6.0	mA	
	Gate-Emitter leakage current	I _{GES}	V _{CE} = 0V V _{GE} = ±20V	-	-	1200	nA	
	Gate-Emitter threshold voltage	V _{GE(th)}	V _{CE} = 20V I _c = 1000mA	6.0	6.5	7.0	V	
	Collector-Emitter saturation voltage	V _{CE(sat)} (terminal) (*4)	I _c = 1000A V _{GE} = 15V	T _J = 25°C	-	2.10	2.55	V
				T _J = 125°C	-	2.50	-	
				T _J = 150°C	-	2.55	-	
		V _{CE(sat)} (chip)		T _J = 25°C	-	2.00	2.45	
				T _J = 125°C	-	2.40	-	
	T _J = 150°C	-	2.45	-				
	Internal gate resistance	R _{G(int)}	-	-	1.17	-	Ω	
Input capacitance	C _{ies}	V _{CE} = 10V, V _{GE} = 0V, f = 1MHz	-	94	-	nF		
Turn-on time	t _{on}	V _{CC} = 900V I _c = 1000A	-	1250	-	nsec		
	t _r	V _{GE} = ±15V	-	500	-			
	t _{r(t)}	R _G = +1.2 / -1.8 Ω	-	150	-			
	t _{off}	L _S = 60nH	-	1550	-			
Turn-off time	t _r	-	-	150	-	nsec		
	t _r	-	-	150	-			
Forward on voltage	V _F (terminal) (*4)	I _F = 1000A V _{GE} = 0V	T _J = 25°C	-	1.95	2.40	V	
			T _J = 125°C	-	2.20	-		
			T _J = 150°C	-	2.15	-		
	V _F (chip)		T _J = 25°C	-	1.85	2.30		
			T _J = 125°C	-	2.10	-		
T _J = 150°C	-	2.05	-					
Reverse recovery time	t _{rr}	I _F = 1000A	-	240	-	nsec		
Reverse Current	I _R	V _{CE} = 1700V	-	-	3.0	mA		
FWD	V _F (terminal) (*4)	I _F = 1000A V _{GE} = 0V	T _J = 25°C	-	1.95	2.40	V	
			T _J = 125°C	-	2.20	-		
			T _J = 150°C	-	2.15	-		
	V _F (chip)		T _J = 25°C	-	1.85	2.30		
			T _J = 125°C	-	2.10	-		
T _J = 150°C	-	2.05	-					
Reverse recovery time	t _{rr}	I _F = 1000A	-	240	-	nsec		
Thermistor	Resistance	R	T = 25°C	-	5000	-	Ω	
		R	T = 100°C	465	495	520		
B value	B	T = 25/50°C	3305	3375	3450	K		

Note *4: Fuji defined V_{CE} value of terminal by using Sense C1 and Sense C2E1 for Upper arm and Sense C2E1 and Sense E2 for Lower arm.

● Thermal resistance characteristics

Items	Symbols	Conditions	Characteristics			Units
			min.	typ.	max.	
Thermal resistance(1device)	R _{th(j-c)}	Inverter IGBT	-	-	0.024	°C/W
		Inverse Diode	-	-	0.048	
		FWD	-	-	0.048	
Contact thermal resistance (1device) (*5)	R _{th(c-f)}	with Thermal Compound	-	0.0083	-	

Note *5: This is the value which is defined mounting on the additional cooling fin with thermal compound.

■ Characteristics (Representative)

Collector current vs. Collector-Emittter voltage (typ.)
 $T_j = 25^\circ\text{C}$ / chip

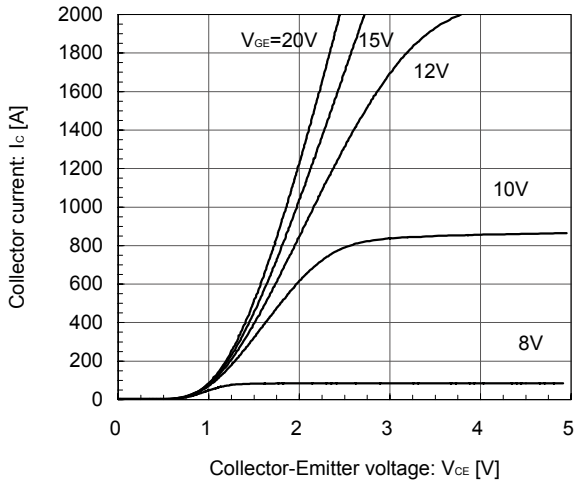

Collector current vs. Collector-Emittter voltage (typ.)
 $T_j = 150^\circ\text{C}$ / chip

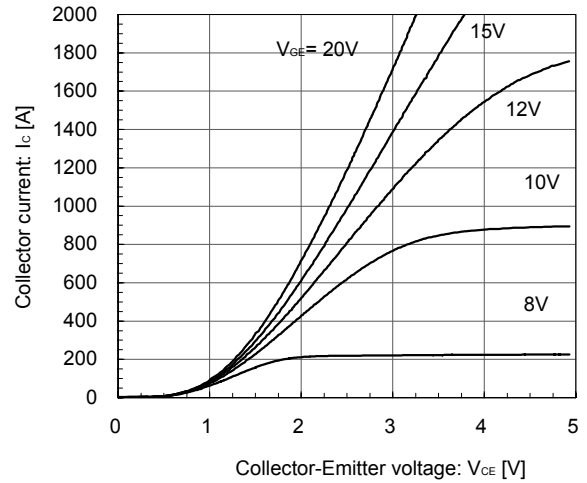

Collector current vs. Collector-Emittter voltage (typ.)
 $V_{ge} = 15\text{V}$ / chip

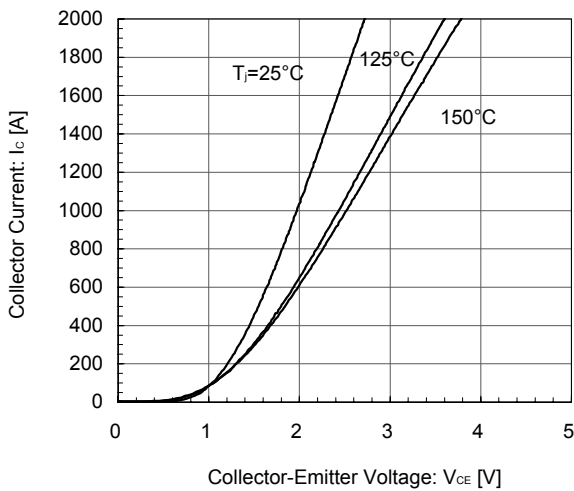

Collector-Emittter voltage vs. Gate-Emittter voltage (typ.)
 $T_j = 25^\circ\text{C}$ / chip

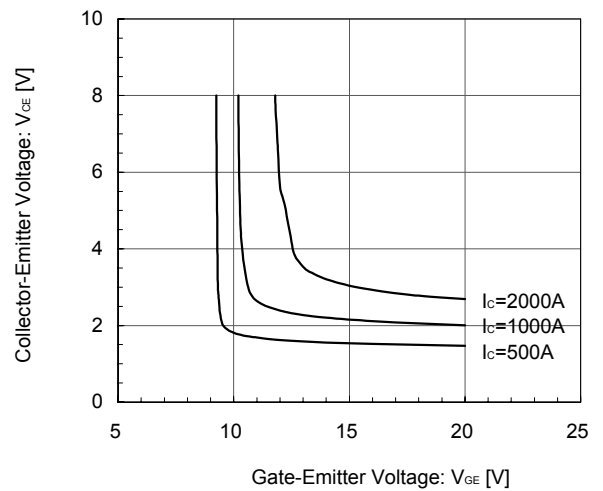

Gate Capacitance vs. Collector-Emittter Voltage (typ.)
 $V_{ge} = 0\text{V}$, $f = 1\text{MHz}$, $T_j = 25^\circ\text{C}$

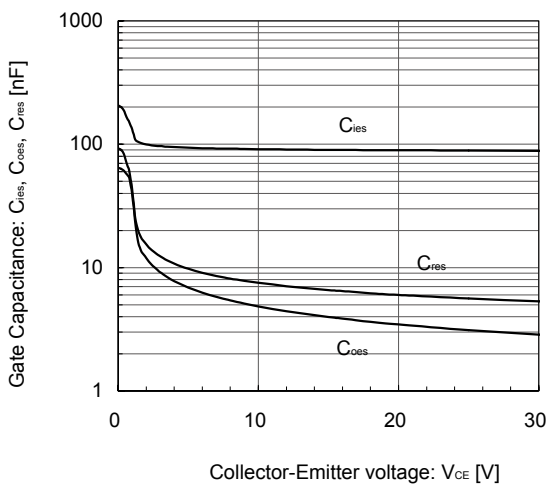

Dynamic Gate Charge (typ.)
 $V_{cc} = 900\text{V}$, $I_c = 1000\text{A}$, $T_j = 25^\circ\text{C}$

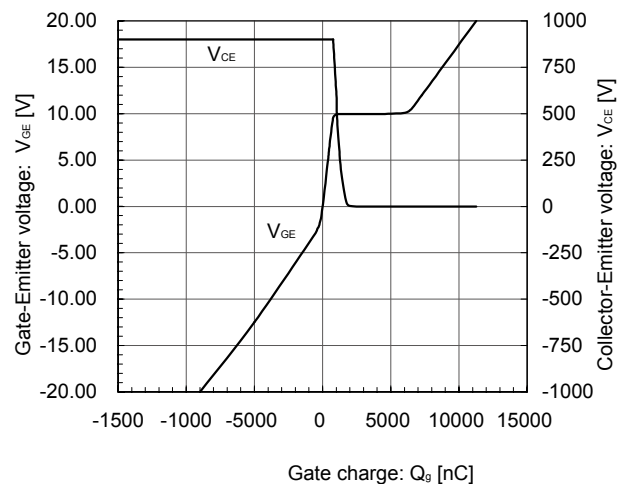

Switching time vs. Collector current (typ.)

$V_{CC}=900V, V_{GE}=\pm 15V, R_G=+1.2/-1.8\Omega, T_J=25^\circ C$

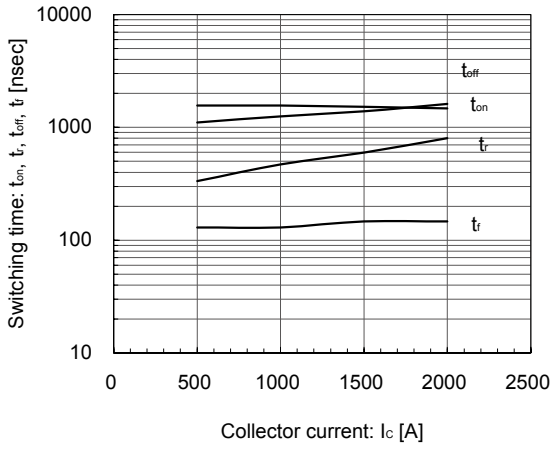

Switching time vs. Collector current (typ.)

$V_{CC}=900V, V_{GE}=\pm 15V, R_G=+1.2/-1.8\Omega, T_J=125^\circ C, 150^\circ C$

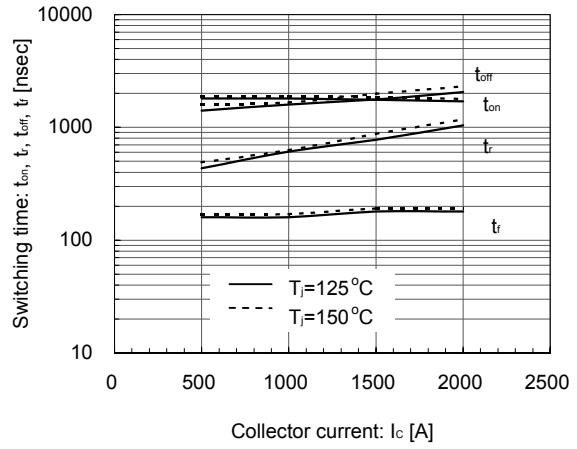

Switching time vs. Gate resistance (typ.)

$V_{CC}=900V, I_C=1000A, V_{GE}=\pm 15V, T_J=125^\circ C, 150^\circ C$

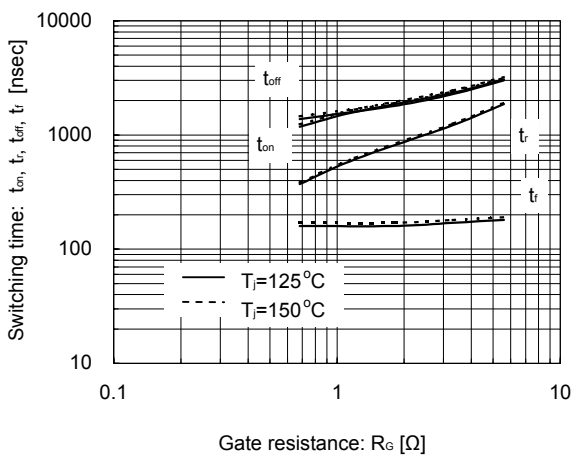

Switching loss vs. Collector current (typ.)

$V_{CC}=900V, V_{GE}=\pm 15V, R_G=+1.2/-1.8\Omega, T_J=125^\circ C, 150^\circ C$

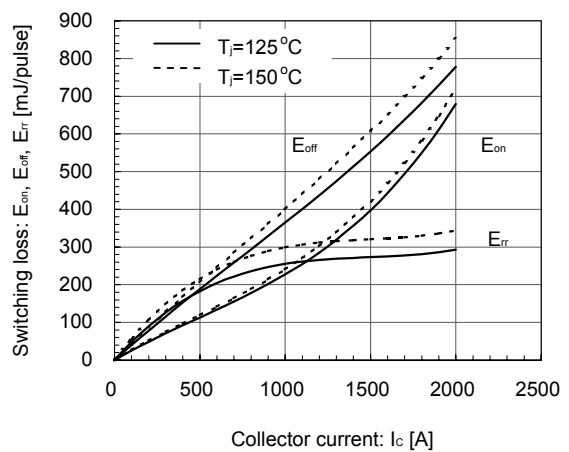

Switching loss vs. Gate resistance (typ.)

$V_{CC}=900V, I_C=1000A, V_{GE}=\pm 15V, T_J=125^\circ C, 150^\circ C$

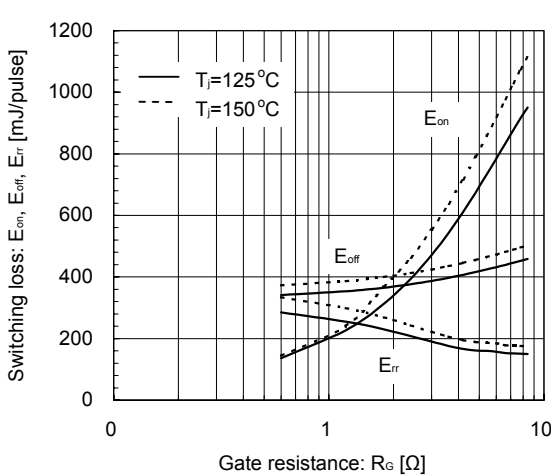

Reverse bias safe operating area (max.)

$+V_{GE}=15V, -V_{GE}=15V, R_G=+1.2/-1.8\Omega, T_J=150^\circ C$

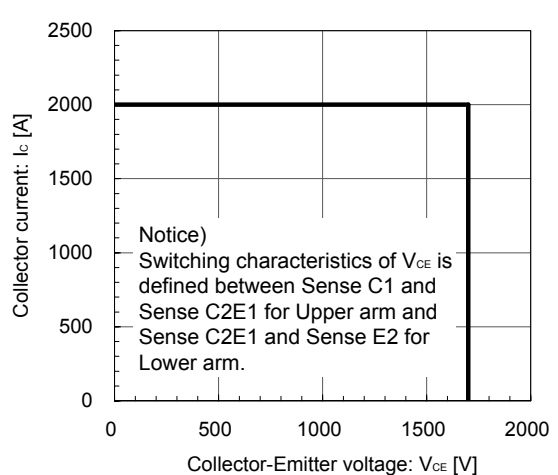

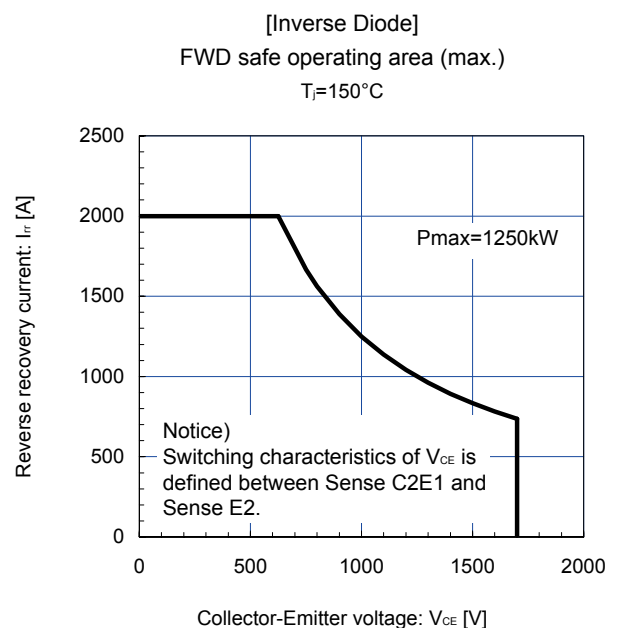
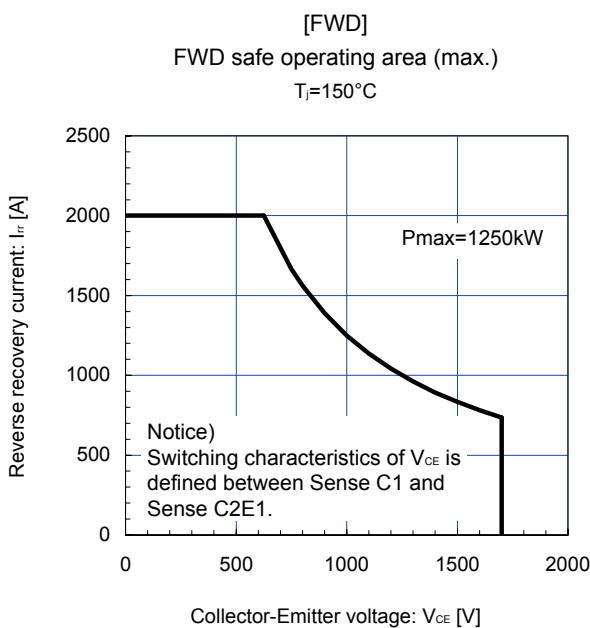
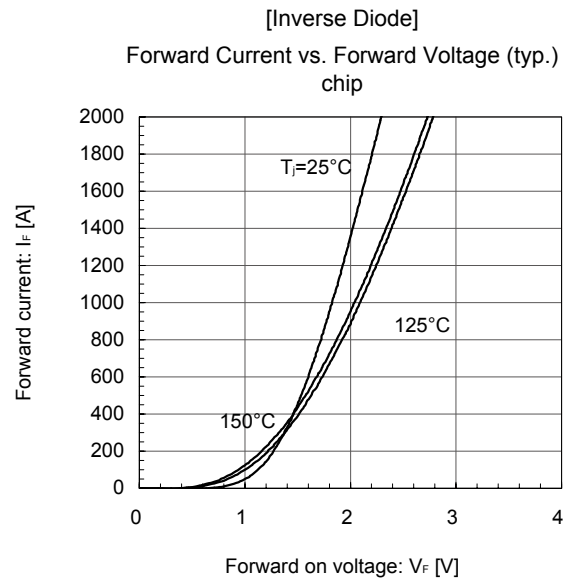
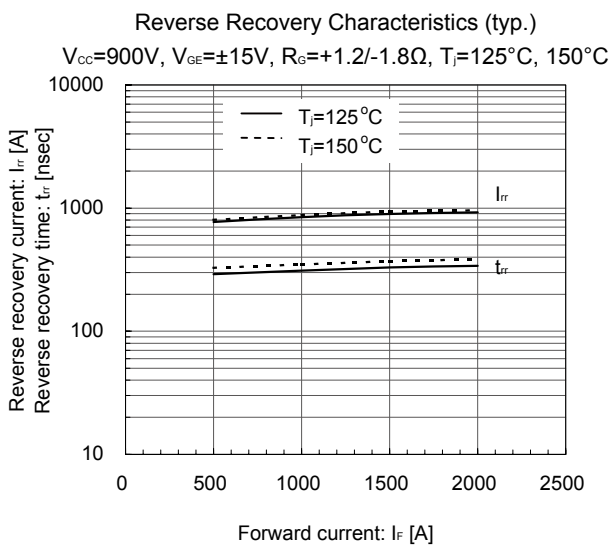
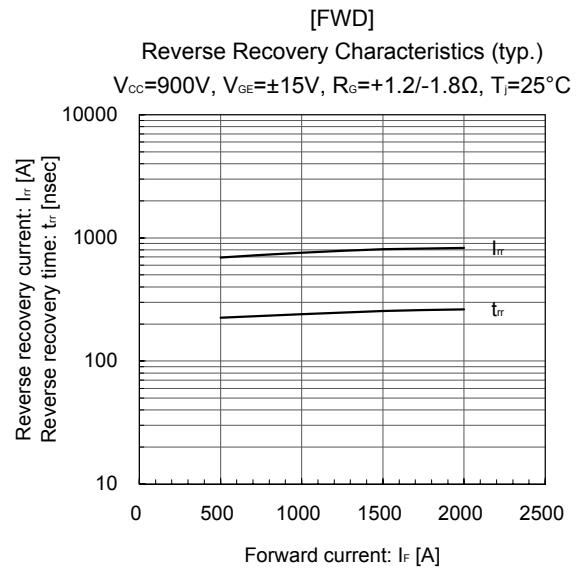
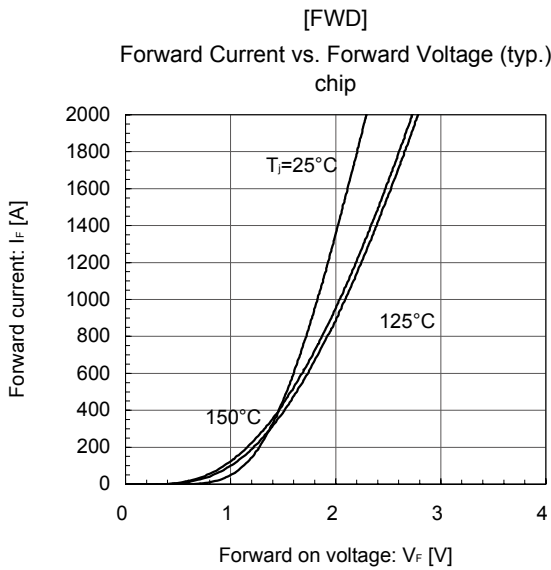

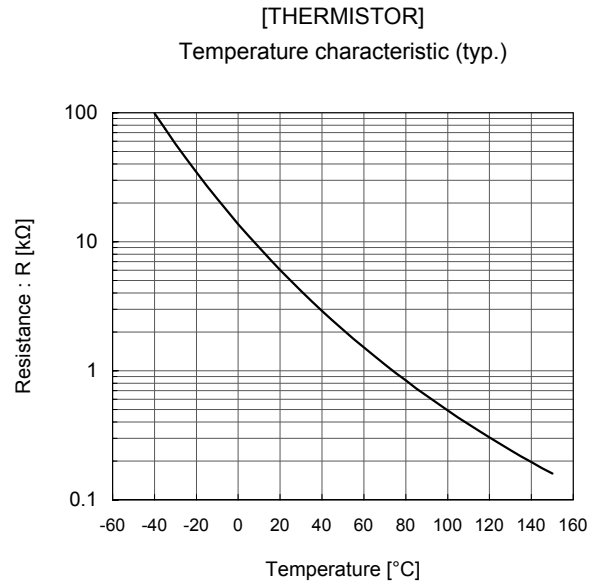
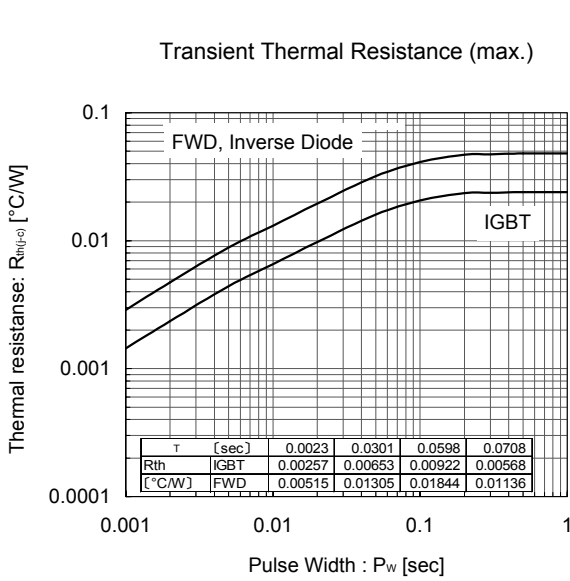

■ Outline Drawings, mm

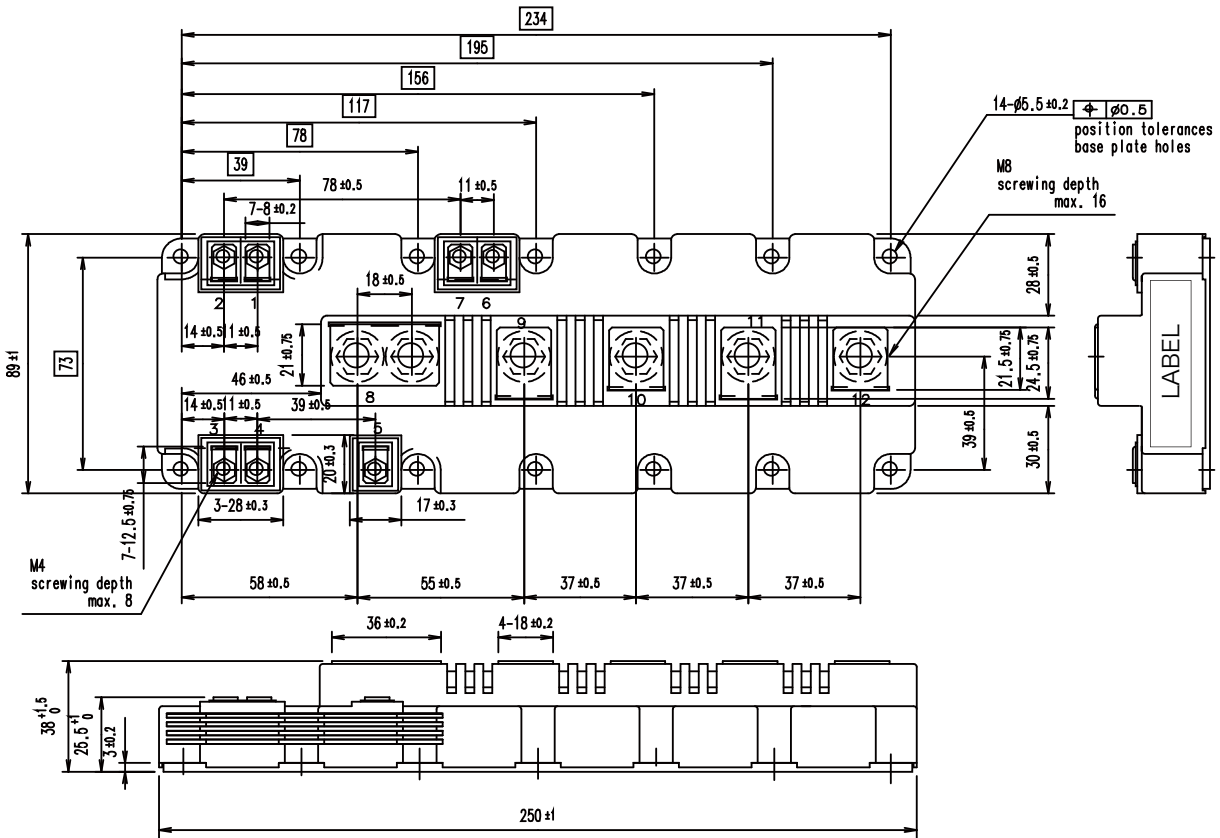

Weight: 1250g (typ.)

Equivalent Circuit Schematic

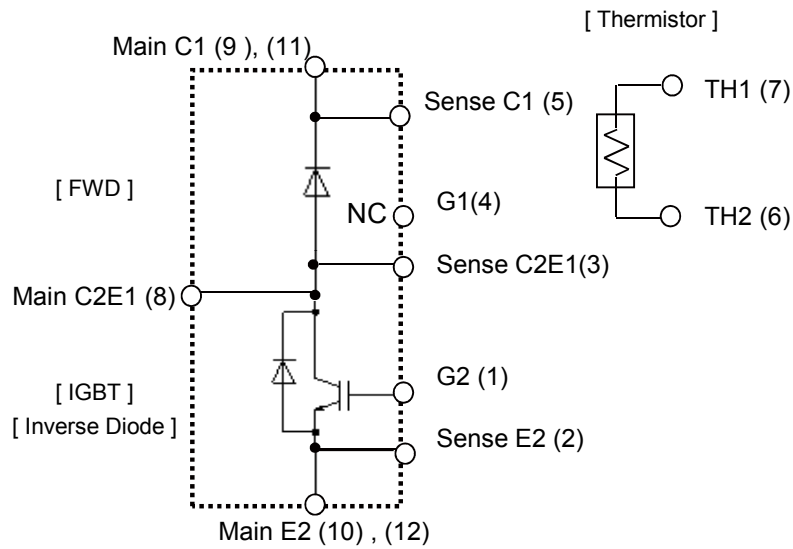

NOTICE

There is recommendation of wiring for NC terminal as follows.

Fuji recommends wire connection of CASE1 or CASE2 to fix NC terminal voltage.

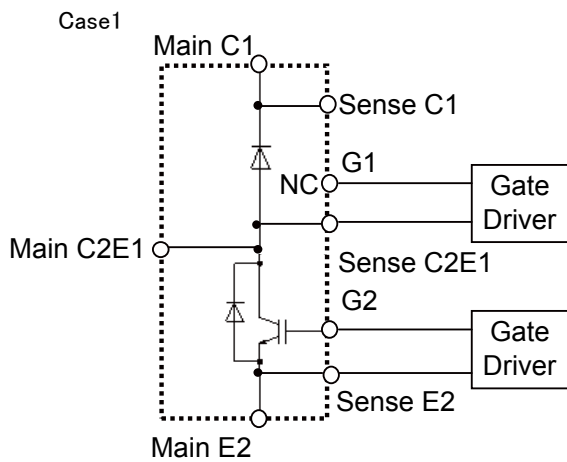

NC terminal (G1) and sense C2E1 should be connected by Gate-Driver.

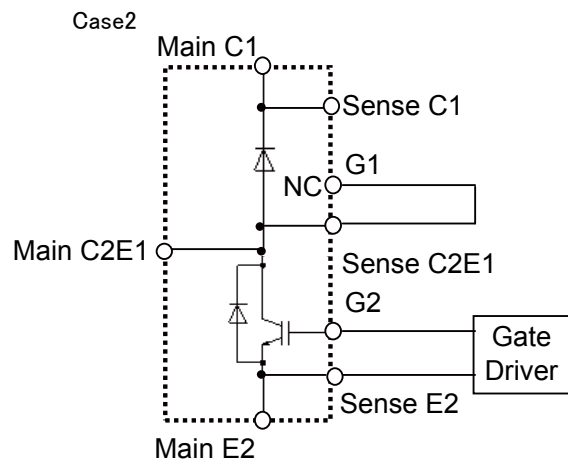

NC terminal (G1) and sense C2E1 should be connected by wire.

WARNING

1. This Catalog contains the product specifications, characteristics, data, materials, and structures as of June 2015. The contents are subject to change without notice for specification changes or other reasons. When using a product listed in this Catalog, be sure to obtain the latest specifications.
2. All applications described in this Catalog exemplify the use of Fuji's products for your reference only. No right or license, either express or implied, under any patent, copyright, trade secret or other intellectual property right owned by Fuji Electric Co., Ltd. is (or shall be deemed) granted. Fuji Electric Co., Ltd. makes no representation or warranty, whether express or implied, relating to the infringement or alleged infringement of other's intellectual property rights which may arise from the use of the applications described herein.
3. Although Fuji Electric Co., Ltd. is enhancing product quality and reliability, a small percentage of semiconductor products may become faulty. When using Fuji Electric semiconductor products in your equipment, you are requested to take adequate safety measures to prevent the equipment from causing a physical injury, fire, or other problem if any of the products become faulty. It is recommended to make your design failsafe, flame retardant, and free of malfunction.
4. The products introduced in this Catalog are intended for use in the following electronic and electrical equipment which has normal reliability requirements.
 - Computers
 - OA equipment
 - Communications equipment (terminal devices)
 - Measurement equipment
 - Machine tools
 - Audiovisual equipment
 - Electrical home appliances
 - Personal equipment
 - Industrial robots etc.
5. If you need to use a product in this Catalog for equipment requiring higher reliability than normal, such as for the equipment listed below, it is imperative to contact Fuji Electric Co., Ltd. to obtain prior approval. When using these products for such equipment, take adequate measures such as a backup system to prevent the equipment from malfunctioning even if a Fuji's product incorporated in the equipment becomes faulty.
 - Transportation equipment (mounted on cars and ships)
 - Trunk communications equipment
 - Traffic-signal control equipment
 - Gas leakage detectors with an auto-shut-off feature
 - Emergency equipment for responding to disasters and anti-burglary devices
 - Safety devices
 - Medical equipment
6. Do not use products in this Catalog for the equipment requiring strict reliability such as the following and equivalents to strategic equipment (without limitation).
 - Space equipment
 - Aeronautic equipment
 - Nuclear control equipment
 - Submarine repeater equipment
7. Copyright ©1996-2015 by Fuji Electric Co., Ltd. All rights reserved.
No part of this Catalog may be reproduced in any form or by any means without the express permission of Fuji Electric Co., Ltd.
8. If you have any question about any portion in this Catalog, ask Fuji Electric Co., Ltd. or its sales agents before using the product. Neither Fuji Electric Co., Ltd. nor its agents shall be liable for any injury caused by any use of the products not in accordance with instructions set forth herein.