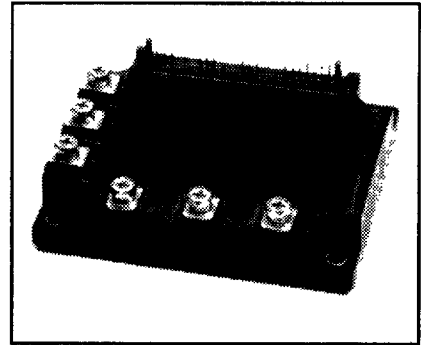
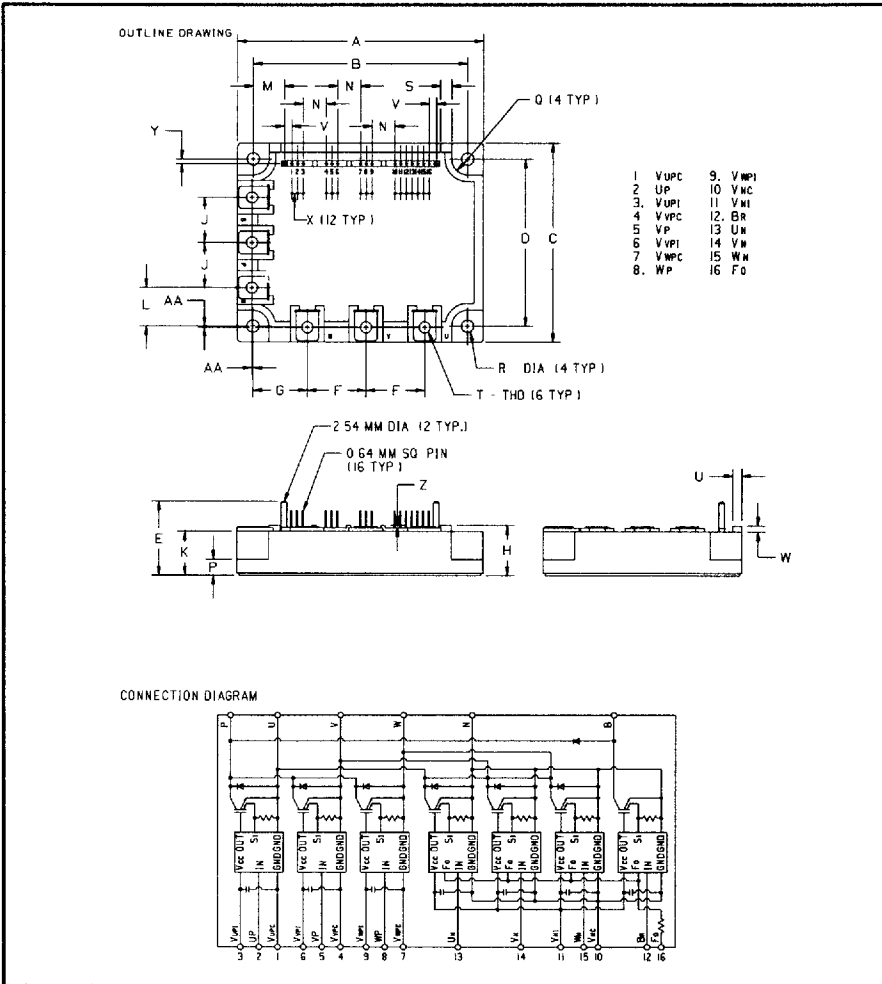




Powerex, Inc., Hillis Street, Youngwood, Pennsylvania 15697 (412) 925-7272  
 Powerex, Europe, S.A. 428 Avenue G. Durand, BP107, 72003 Le Mans, France (43) 41.14.14

**Intellimod™-3 Modules**  
 Three Phase + Brake  
 IGBT Inverter Output  
 75 Amperes/110-230 Volt Line



**Description**

Powerex Intellimod-3 Modules are designed for applications requiring a high frequency (20kHz) output switching inverter. The modules are isolated from the baseplate, consisting of complete drive, control and protection circuitry for the IGBT inverter.

**Features:**

- Complete Output Power Circuit
- Gate Drive Circuit
- Protection Logic
  - Short Circuit
  - Over-Current
  - Over Temperature
  - Under Voltage

**Applications:**

- Inverters
- Small UPS
- Motion/Servo Control
- AC Motor Control

**Ordering Information**  
 PM75RHA060

110-230 Volt Line, PM75RHA060 Outline Drawing

Dimensions	Inches	Millimeters
A	4.29±0.04	109.0±1.0
B	3.74±0.02	95.0±0.5
C	3.46±0.04	88.0±1.0
D	2.91±0.02	74.0±0.5
E	1.28	32.6
F	1.02	26.0
G	0.94	24.0
H	0.87	22.0
J	0.79	20.0
K	0.76	19.4
L	0.67	17.0
M	0.54	13.8
N	0.4	10.16

Dimensions	Inches	Millimeters
P	0.28	7.0
Q	0.38 R	7.0 R
R	0.22 Dia.	5.5 Dia.
S	0.2	5.0
T	M5 Metric	M5
U	0.16	4.0
V	0.127	3.22
W	0.1	2.6
X	0.1	2.54
Y	0.08	2.0
Z	0.04	1.0
AA	0.02	0.5



POWEREX INC

51E D ■ 7294621 0005697 800 ■ PRX

Powerex, Inc., Hillis Street, Youngwood, Pennsylvania 15697 (412) 925-7272  
 Powerex, Europe, S.A. 428 Avenue G. Durand, BP107, 72003 Le Mans, France (43) 41.14.14

**PM75RHA060**  
**Intellimod-3 Modules**  
**Three Phase + Brake IGBT Inverter Output**  
 75 Amperes/110-230 Volt Line

T-57-29

**Absolute Maximum Ratings,  $T_j = 25^\circ\text{C}$  unless otherwise specified**

Characteristics	Symbol	PM75RHA060	Units
Power Device Junction Temperature	$T_j$	-20 to +150	$^\circ\text{C}$
Storage Temperature	$T_{STG}$	-40 to +125	$^\circ\text{C}$
Case Operating Temperature	$T_C$	-20 to +100	$^\circ\text{C}$
Mounting Torque, M5 Mounting Screws	—	17	Kg-cm
Mounting Torque, M5 Main Terminal Screws	—	17	Kg-cm
Module Weight (Typical)	—	550	Grams
Supply Voltage Protected by OC and SC ( $V_D = 13.5 - 16.5\text{V}$ , Inverter Part)	$V_{CC(prot)}$	400	Volts
Isolation Voltage AC 1 minute, 60Hz	$V_{RMS}$	2500	Volts

**Control Sector**

Supply Voltage Applied between ( $V_{UP1} - V_{UPC}, V_{VP1} - V_{VPC}, V_{WP1} - V_{WPC}, V_{N1} - V_{NC}$ )	$V_D$	20	Volts
Input Voltage Applied between ( $U_P, V_P, U_N, V_N, W_N, B_r$ )	$V_{CIN}$	20	Volts
Fault Output Supply Voltage	$V_{FO}$	20	Volts
Fault Output Current	$I_{FO}$	20	mA

**IGBT Inverter Sector**

Collector-Emitter Voltage Fig. 1	$V_{CES}$	600	Volts
Collector Current $\pm$	$I_C$	75	Amperes
Peak Collector Current $\pm$	$I_{CP}$	150	Amperes
Supply Voltage (Applied between P - N)	$V_{CC}$	400	Volts
Supply Voltage (Surge) Applied between P - N	$V_{CC(surge)}$	500	Volts
Collector Dissipation	$P_C$	312	Watts

**Brake Sector**

Collector-Emitter Voltage Fig. 1	$V_{CES}$	600	Volts
Collector Current $\pm$	$I_C$	30	Amperes
Peak Collector Current $\pm$	$I_{CP}$	60	Amperes
Supply Voltage (Applied between P - N)	$V_{CC}$	400	Volts
Supply Voltage (Surge) Applied between P - N	$V_{CC(surge)}$	500	Volts
Collector Dissipation	$P_C$	208	Watts
Diode Forward Current	$I_F$	30	Amperes
Diode DC Reverse Voltage	$V_{R(DC)}$	600	Volts



POWEREX INC

51E D ■ 7294621 0005698 747 ■ PRX ■

Powerex, Inc., Hillis Street, Youngwood, Pennsylvania 15697 (412) 925-7272  
 Powerex, Europe, S.A. 428 Avenue G. Durand, BP107, 72003 Le Mans, France (43) 41.14.14

T-57-29

PM75RHA060  
 Intellimod-3 Modules  
 Three Phase + Brake IGBT Inverter Output  
 75 Amperes/110-230 Volt Line

**Electrical Characteristics,  $T_j = 25^\circ\text{C}$  unless otherwise specified**

Characteristics	Symbol	Test Conditions	Min.	Typ.	Max.	Units
<b>Control Sector</b>						
Overcurrent Trip Level Inverter Part	OC	$-20^\circ\text{C} \leq T \leq 125^\circ\text{C}, V_D = 15\text{V}$	115	161	–	Amperes
Overcurrent Trip Level Brake Part			39	53	–	Amperes
Short Circuit Trip Level Inverter Part	SC	$-20^\circ\text{C} \leq T \leq 125^\circ\text{C}, V_D = 15\text{V}$	–	241	–	Amperes
Short Circuit Trip Level Brake Part			–	79	–	Amperes
Over Current Delay Time	$t_{\text{off(OC)}}$	$V_D = 15\text{V}, \text{Fig. 7}$	–	10	–	$\mu\text{S}$
Over Temperature Protection	OT	Trip Level	111	118	125	$^\circ\text{C}$
Over Temperature Protection	$\text{OT}_R$	Reset Level	–	100	–	$^\circ\text{C}$
Supply Circuit Under Voltage Protection	UV	Trip Level	11.5	12.0	12.5	Volts
Supply Circuit Under Voltage Protection	$\text{UV}_R$	Reset Level	–	12.5	–	Volts
Supply Voltage	$V_D$	Applied between $V_{\text{UP1}} - V_{\text{UPC}}, V_{\text{VP1}} - V_{\text{VPC}}, V_{\text{WP1}} - V_{\text{WPC}}, V_{\text{N1}} - V_{\text{NC}}$	13.5	15	16.5	Volts
Circuit Current	$I_D$	$V_D = 15\text{V}, V_{\text{CIN}} = 15\text{V}, V_{\text{N1}} - V_{\text{NC}}$	–	80	120	mA
	$I_D$	$V_D = 15\text{V}, V_{\text{CIN}} = 15\text{V}, V_{\text{XP1}} - V_{\text{XPC}}$	–	25	35	mA
Input On Voltage	$V_{\text{CIN(on)}}$	Applied between $V_{\text{UP1}} - V_{\text{UPC}}, V_{\text{VP1}} - V_{\text{VPC}}, V_{\text{WP1}} - V_{\text{WPC}}, V_{\text{N1}} - V_{\text{NC}}, B_T - V_{\text{NC}}$	1.2	1.5	1.8	Volts
Input Off Voltage	$V_{\text{CIN(off)}}$	Applied between $V_{\text{UP1}} - V_{\text{UPC}}, V_{\text{VP1}} - V_{\text{VPC}}, V_{\text{WP1}} - V_{\text{WPC}}, V_{\text{N1}} - V_{\text{NC}}, B_T - V_{\text{NC}}$	1.7	2.0	2.3	Volts
PWM Input Frequency	$f_{\text{PWM}}$	3- $\emptyset$ Sinusoidal	–	15	20	kHz
Dead Time	$t_{\text{DEAD}}$	For each Input Pulse	3.0	–	–	$\mu\text{S}$
		Using example Interface Circuit*	5.0	–	–	$\mu\text{S}$
Fault Output Current	$I_{\text{FO(H)}}$	$V_D = 15\text{V}, V_{\text{FO}} = 15\text{V}$	–	–	0.01	mA
	$I_{\text{FO(L)}}$	$V_D = 15\text{V}, V_{\text{FO}} = 15\text{V}$	–	10	15	mA
Minimum Fault Output Pulse Width	$t_{\text{FO}}$	$V_D = 15\text{V}$	1.0	2.0	–	mS
		Using example Interface Circuit* $V_D = 15\text{V}$	1.0	2.0	–	mS
<b>Brake Sector</b>						
Collector Emitter Saturation Voltage	$V_{\text{CE(sat)}}$	$V_D = 15\text{V}, V_{\text{CIN}} = 0\text{V}, I_C = 30\text{A}, T_j = 25^\circ\text{C}, \text{Fig. 2}$	–	2.7	3.5	Volts
		$V_D = 15\text{V}, V_{\text{CIN}} = 0\text{V}, I_C = 30\text{A}, T_j = 125^\circ\text{C}, \text{Fig. 2}$	–	3.1	4.0	Volts
Diode Forward Voltage	$V_{\text{FM}}$	$I_C = 30\text{A}, V_D = 15\text{V}, V_{\text{CIN}} = 15\text{V}, \text{Fig. 3}$	–	1.7	2.7	Volts
Collector Cutoff Current	$I_{\text{CEX}}$	$V_{\text{CE}} = V_{\text{CES}}, T_j = 25^\circ\text{C}, \text{Fig. 6}$	–	–	1	mA
		$V_{\text{CE}} = V_{\text{CES}}, T_j = 125^\circ\text{C}, \text{Fig. 6}$	–	–	10	mA

\*See Intellimod-3 Applications Data Section 4.3.



POWEREX INC

51E D ■ 7294621 0005699 683 ■ PRX

Powerex, Inc., Hillis Street, Youngwood, Pennsylvania 15697 (412) 925-7272  
 Powerex, Europe, S.A. 428 Avenue G. Durand, BP107, 72003 Le Mans, France (43) 41.14.14

PM75RHA060  
 Intellimod-3 Modules  
 Three Phase + Brake IGBT Inverter Output  
 75 Amperes/110-230 Volt Line

T-57-29

**Electrical Characteristics,  $T_j = 25^\circ\text{C}$  unless otherwise specified**

Characteristics	Symbol	Test Conditions	Min.	Typ.	Max.	Units
<b>IGBT Inverter Sector</b>						
Collector Cutoff Current	$I_{CEX}$	$V_{CE} = V_{CES}, T_j = 25^\circ\text{C}$ , Fig. 6	-	-	1	mA
Collector Cutoff Current	$I_{CEX}$	$V_{CE} = V_{CES}, T_j = 125^\circ\text{C}$ , Fig. 6	-	-	10	mA
Diode Forward Voltage	$V_{FM}$	$-I_C = 75\text{A}, V_D = 15\text{V}, V_{CIN} = 15\text{V}$ , Fig. 3	-	1.6	2.5	Volts
Collector Emitter Saturation Voltage	$V_{CE(sat)}$	$V_D = 15\text{V}, V_{CIN} = 0\text{V}, T_j = 25^\circ\text{C}$ , $I_C = 75\text{A}$ , Fig. 2	-	2.7	3.5	Volts
Collector Emitter Saturation Voltage	$V_{CE(sat)}$	$V_D = 15\text{V}, V_{CIN} = 0\text{V}, T_j = 125^\circ\text{C}$ , $I_C = 75\text{A}$ , Fig. 2	-	2.5	3.4	Volts
Inductive Load Switching Times	$t_{on}$	$V_D = 15\text{V}, V_{CIN} = 0\text{V}$ ,	0.3	0.5	1.5	$\mu\text{S}$
	$t_{rr}$	$V_{CC} = 300\text{V}, I_C = 75\text{A}$ ,	-	0.25	0.4	$\mu\text{S}$
	$t_{C(on)}$	$T_j = 125^\circ\text{C}$	-	0.4	1.2	$\mu\text{S}$
	$t_{off}$	Fig. 4, 5	-	2.0	3.3	$\mu\text{S}$
	$t_{C(off)}$		-	0.6	1.2	$\mu\text{S}$

**Thermal Characteristics**

Characteristics	Symbol	Test Conditions	Min.	Typ.	Max.	Units
Thermal Resistances Junction to Case	$R_{th(j-c)Q}$	Inverter IGBT	-	-	0.4	$^\circ\text{C/W}$
	$R_{th(j-c)F}$	Inverter FWD	-	-	1.0	$^\circ\text{C/W}$
	$R_{th(j-c)Q}$	Brake IGBT	-	-	0.6	$^\circ\text{C/W}$
	$R_{th(j-c)F}$	Brake FWD	-	-	1.5	$^\circ\text{C/W}$
Contact Thermal Resistance	$R_{th(c-f)}$	Case to Fin, Thermal Grease Applied	-	-	0.19	$^\circ\text{C/W}$

**Recommended Operating Conditions**

Characteristics	Symbol	Test Conditions	Value	Units
Supply Voltage	$V_{CC}$	Applied across P - N Terminals	0 ~ 400	Volts
	$V_D$	Applied between $V_{UP1} - V_{UPC}$ , $V_{N1} - V_{NC}$ , $V_{VP1} - V_{VPC}$ , $V_{WP1} - V_{WPC}$	15±1.5	Volts
Input On Voltage	$V_{CIN(on)}$	Applied between	0 ~ 0.8	Volts
Input Off Voltage	$V_{CIN(off)}$	$U_P, V_P, W_P, U_N, V_N, W_N, B_I$	4 ~ 15	Volts
PWM Input Frequency	$f_{PWM}$	Using example Interface Circuit *	5 ~ 20	kHz
Minimum Dead Time	$t_{DEAD}$	Using example Interface Circuit *	5.0	$\mu\text{S}$

\*See Intellimod-3 Applications Data Section 4.3.



POWEREX INC

51E D 7294621 0005700 125 PRX

Powerex, Inc., Hillis Street, Youngwood, Pennsylvania 15697 (412) 925-7272

Powerex, Europe, S.A. 428 Avenue G. Durand, BP107, 72003 Le Mans, France (43) 41.14.14

PM75RHA060

Intellimod-3 Modules

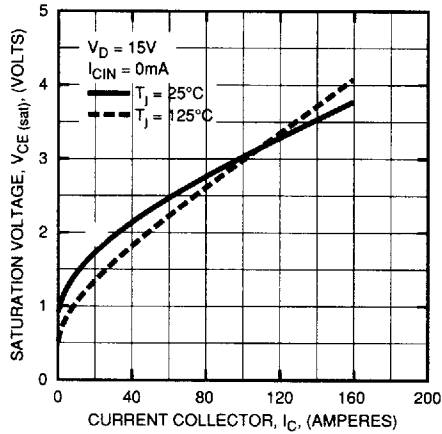
Three Phase + Brake IGBT Inverter Output

75 Amperes/110-230 Volt Line

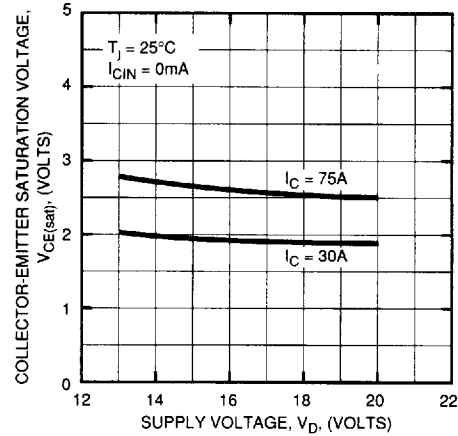
Inverter Part

T-57-29

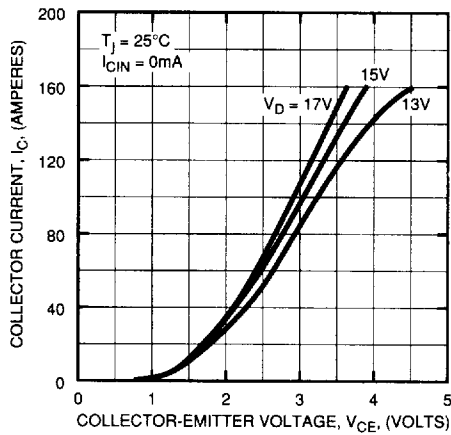
SATURATION VOLTAGE CHARACTERISTICS (TYPICAL)



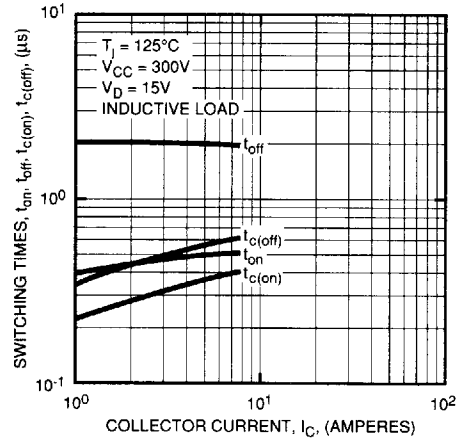
COLLECTOR-EMITTER SATURATION VOLTAGE (TYPICAL)



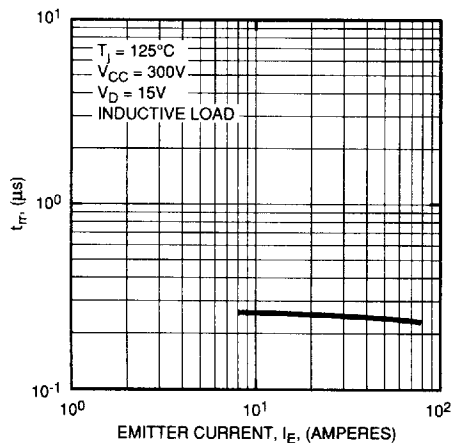
OUTPUT CHARACTERISTICS (TYPICAL)



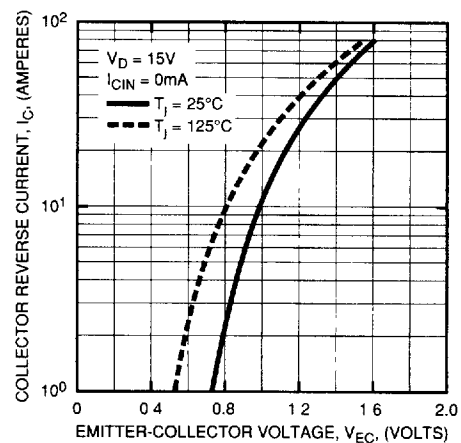
SWITCHING TIME VS. COLLECTOR CURRENT (TYPICAL)



REVERSE RECOVERY CHARACTERISTICS OF FREE-WHEEL DIODE (TYPICAL)



REVERSE COLLECTOR CURRENT VS. EMITTER-COLLECTOR VOLTAGE (DIODE FORWARD CHARACTERISTICS) (TYPICAL)



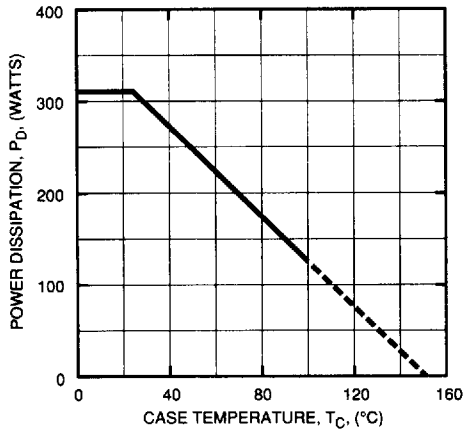


T-57-29

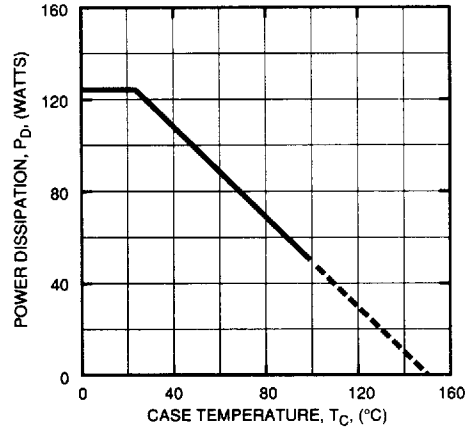
Powerex, Inc., Hillis Street, Youngwood, Pennsylvania 15697 (412) 925-7272  
 Powerex, Europe, S.A. 428 Avenue G. Durand, BP107, 72003 Le Mans, France (43) 41.14.14

**PM75RHA060**  
**Intellimod-3 Modules**  
**Three Phase + Brake IGBT Inverter Output**  
 75 Amperes/110-230 Volt Line  
 Inverter Part

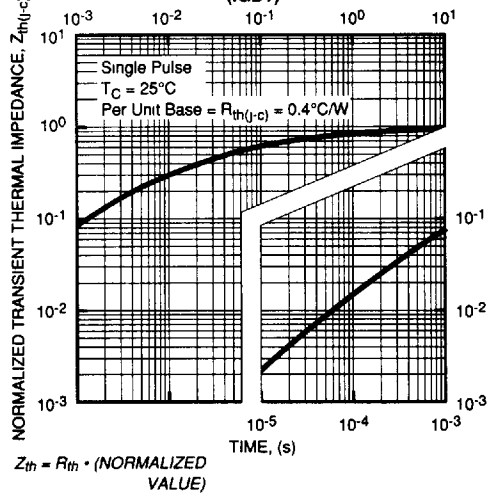
**POWER DISSIPATION DERATING CURVE  
 (PER IGBT ELEMENT)**



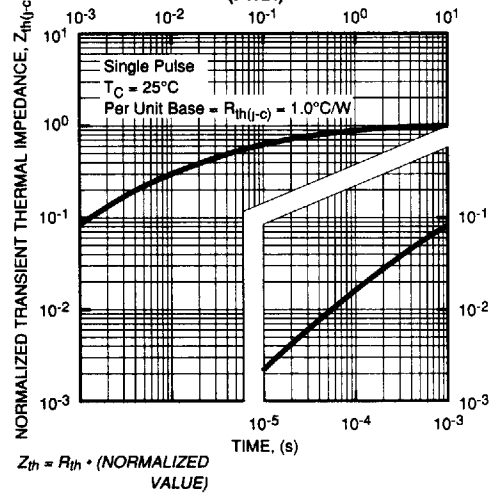
**POWER DISSIPATION DERATING CURVE  
 (PER FWDI ELEMENT)**



**TRANSIENT THERMAL  
 IMPEDANCE CHARACTERISTICS  
 (IGBT)**



**TRANSIENT THERMAL  
 IMPEDANCE CHARACTERISTICS  
 (FWDI)**





POWEREX INC

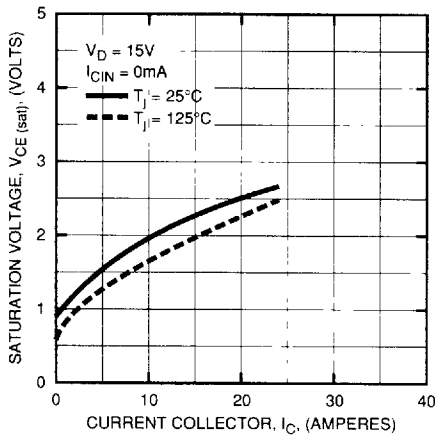
51E D ■ 7294621 0005702 TT8 ■ PRX

Powerex, Inc., Hillis Street, Youngwood, Pennsylvania 15697 (412) 925-7272  
Powerex, Europe, S.A. 428 Avenue G. Durand, BP107, 72003 Le Mans, France (43) 41.14.14

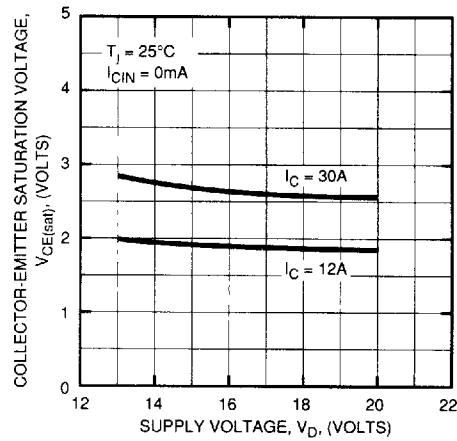
T-57-29

**PM75RHA060**  
**Intellimod-3 Modules**  
**Three Phase + Brake IGBT Inverter Output**  
**75 Amperes/110-230 Volt Line**  
**Brake Part**

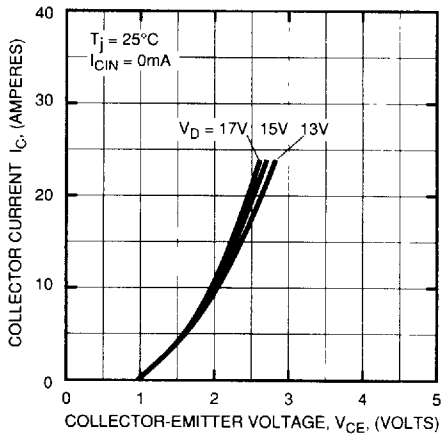
**SATURATION VOLTAGE CHARACTERISTICS (TYPICAL)**



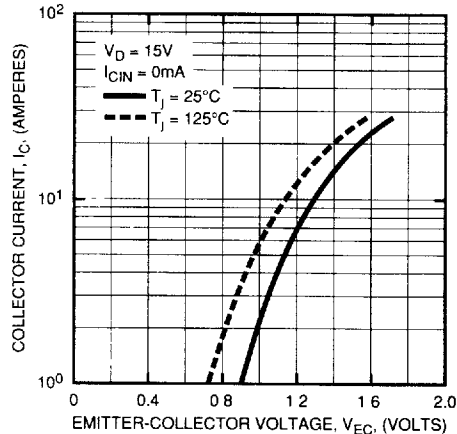
**COLLECTOR-EMITTER SATURATION VOLTAGE (TYPICAL)**



**OUTPUT CHARACTERISTICS (TYPICAL)**



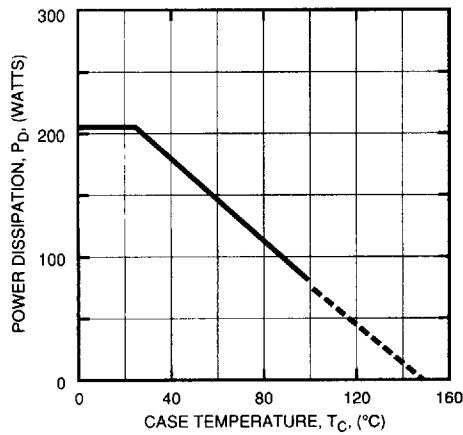
**REVERSE COLLECTOR CURRENT VS. EMITTER-COLLECTOR VOLTAGE (DIODE FORWARD CHARACTERISTICS) (TYPICAL)**



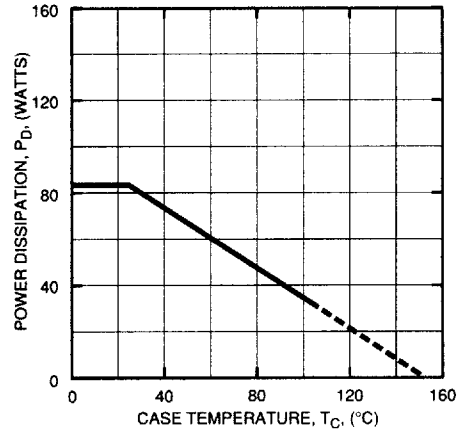
Powerex, Inc., Hillis Street, Youngwood, Pennsylvania 15697 (412) 925-7272  
 Powerex, Europe, S.A. 428 Avenue G. Durand, BP107, 72003 Le Mans, France (43) 41.14.14

**PM75RHA060**  
**Intellimod-3 Modules**  
**Three Phase + Brake IGBT Inverter Output**  
 75 Amperes/110-230 Volt Line  
**Brake Part**

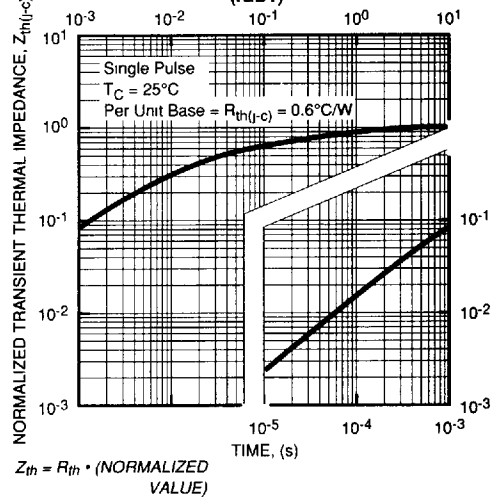
**POWER DISSIPATION DERATING CURVE  
 (PER IGBT ELEMENT)**



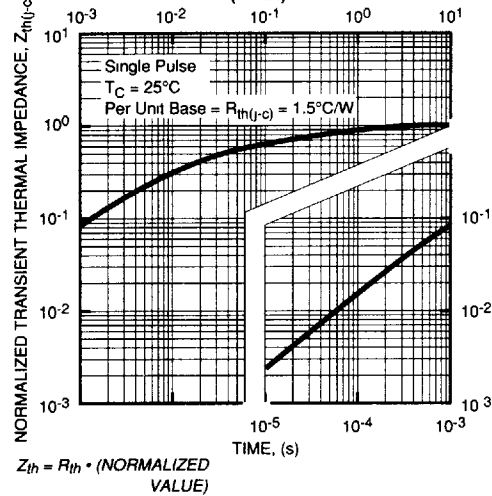
**POWER DISSIPATION DERATING CURVE  
 (PER FWDI ELEMENT)**



**TRANSIENT THERMAL  
 IMPEDANCE CHARACTERISTICS  
 (IGBT)**



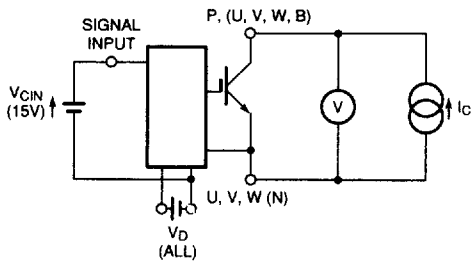
**TRANSIENT THERMAL  
 IMPEDANCE CHARACTERISTICS  
 (FWDI)**



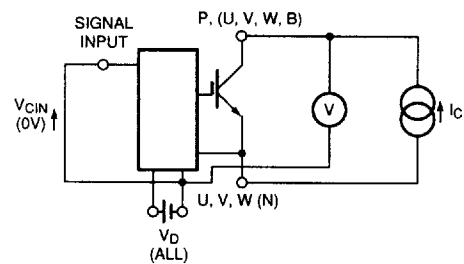


Powerex, Inc., Hillis Street, Youngwood, Pennsylvania 15697 (412) 925-7272  
 Powerex, Europe, S.A. 428 Avenue G. Durand, BP107, 72003 Le Mans, France (43) 41.14.14

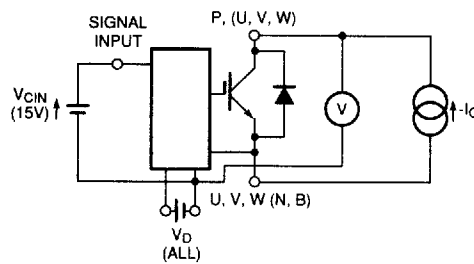
**PM75RHA060**  
**Intellimod-3 Modules**  
**Three Phase + Brake IGBT Inverter Output**  
 75 Amperes/110-230 Volt Line



**Figure 1  $V_{CES}$  Test**

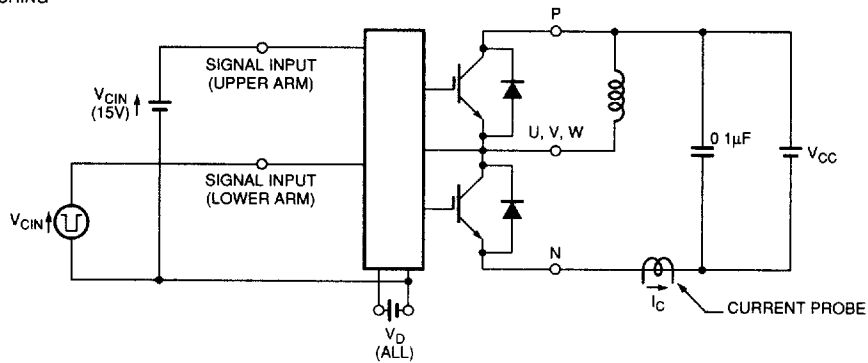


**Figure 2  $V_{CE(SAT)}$  Test**

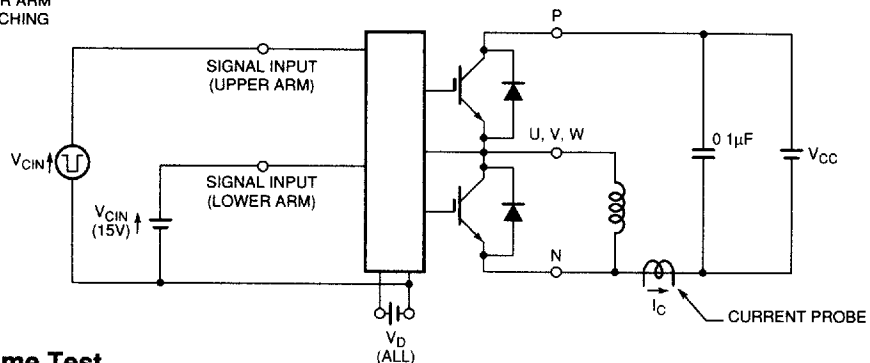


**Figure 3  $V_{EC}$  Test**

A) LOWER ARM SWITCHING



B) UPPER ARM SWITCHING



**Figure 4 Switching Time Test**

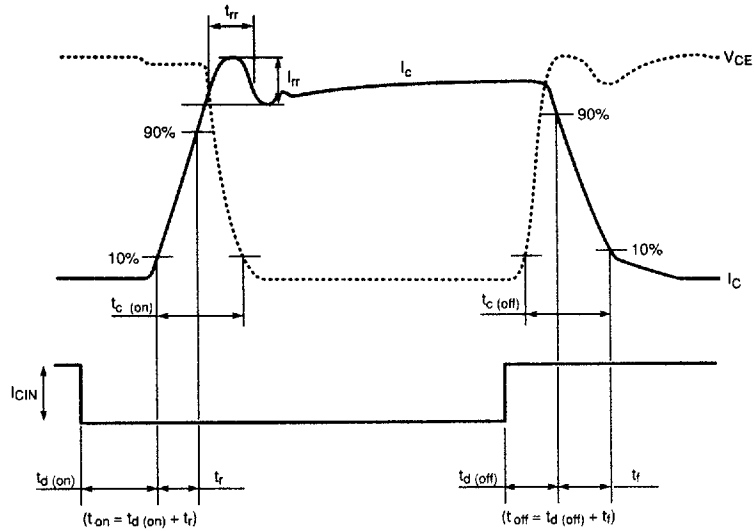
T-57-29

**PM75RHA060**

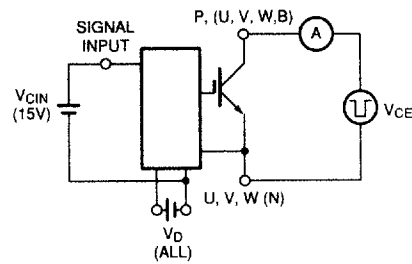
**Intellimod-3 Modules**

**Three Phase + Brake IGBT Inverter Output**

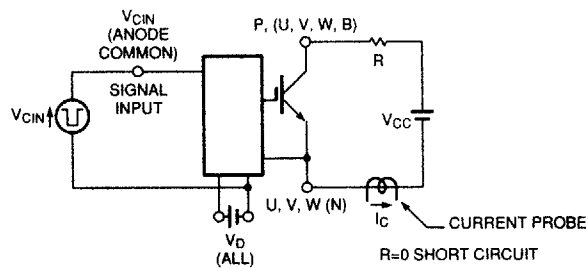
75 Amperes/110-230 Volt Line



**Figure 5 Switching Test Waveform**



**Figure 6 I<sub>CES</sub> Test**



**Figure 7 Over Current and Short Circuit Test**