



SEMIPACK® 1

Thyristor / Diode Modules

SKKH 58/16 E

Features

- Heat transfer through aluminium oxide ceramic isolated metal baseplate
- UL recognized, file no. E63532

Typical Applications*

- DC motor control (e. g. for machine tools)
- AC motor soft starters
- Temperature control (e. g. for ovens, chemical processes)
- Professional light dimming (studios, theaters)

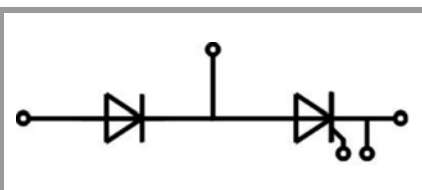

SKKH

Absolute Maximum Ratings				
Symbol	Conditions		Values	Unit
Chip				
$I_{T(AV)}$	sinus 180°	$T_c = 85\text{ °C}$	55	A
		$T_c = 100\text{ °C}$	41	A
I_{TSM}	10 ms	$T_j = 25\text{ °C}$	1500	A
		$T_j = 130\text{ °C}$	1200	A
i^2t	10 ms	$T_j = 25\text{ °C}$	11250	A ² s
		$T_j = 130\text{ °C}$	7200	A ² s
V_{RSM}			1700	V
V_{RRM}			1600	V
V_{DRM}			1600	V
$(di/dt)_{cr}$	$T_j = 130\text{ °C}$		140	A/μs
$(dv/dt)_{cr}$	$T_j = 130\text{ °C}$		1000	V/μs
T_j			-40 ... 130	°C
Module				
T_{stg}			-40 ... 125	°C
V_{isol}	a.c.; 50 Hz; r.m.s.	1 min	3000	V
		1 s	3600	V

Characteristics						
Symbol	Conditions		min.	typ.	max.	Unit
Chip						
V_T	$T_j = 25\text{ °C}, I_T = 180\text{ A}$			1.5	1.75	V
$V_{T(TO)}$	$T_j = 130\text{ °C}$			0.85	1	V
r_T	$T_j = 130\text{ °C}$			4.00	4.80	mΩ
$I_{DD}; I_{RD}$	$T_j = 130\text{ °C}, V_{DD} = V_{DRM}; V_{RD} = V_{RRM}$				20	mA
t_{gd}	$T_j = 25\text{ °C}, I_G = 1\text{ A}, di_G/dt = 1\text{ A}/\mu\text{s}$			1		μs
t_{gr}	$V_D = 0.67 * V_{DRM}$			2		μs
t_q	$T_j = 130\text{ °C}$			170		μs
I_H	$T_j = 25\text{ °C}$			150	250	mA
I_L	$T_j = 25\text{ °C}, R_G = 33\text{ Ω}$			300	600	mA
V_{GT}	$T_j = 25\text{ °C}, \text{d.c.}$		2.5			V
I_{GT}	$T_j = 25\text{ °C}, \text{d.c.}$		100			mA
V_{GD}	$T_j = 130\text{ °C}, \text{d.c.}$				0.25	V
I_{GD}	$T_j = 130\text{ °C}, \text{d.c.}$				4	mA
$R_{th(j-c)}$	continuous DC	per chip			0.470	K/W
		per module			0.235	K/W
$R_{th(j-c)}$	sin. 180°	per chip			0.490	K/W
		per module			0.245	K/W
$R_{th(j-c)}$	rec. 120°	per chip			0.510	K/W
		per module			0.255	K/W
Module						
$R_{th(c-s)}$	chip			0.22		K/W
	module			0.11		K/W
M_s	to heatsink M5		4.25		5.75	Nm
M_t	to terminals M5		2.55		3.45	Nm
a					5 * 9,81	m/s ²
w				75		g

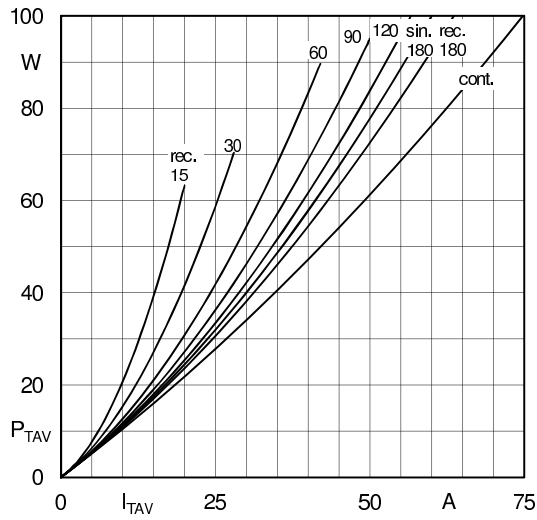

Fig. 1L: Power dissipation per thyristor/diode vs. on-state current

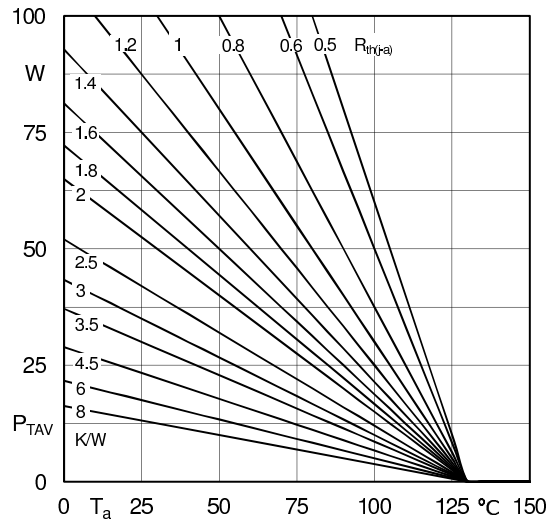

Fig. 1R: Max. power dissipation per chip vs. ambient temperature

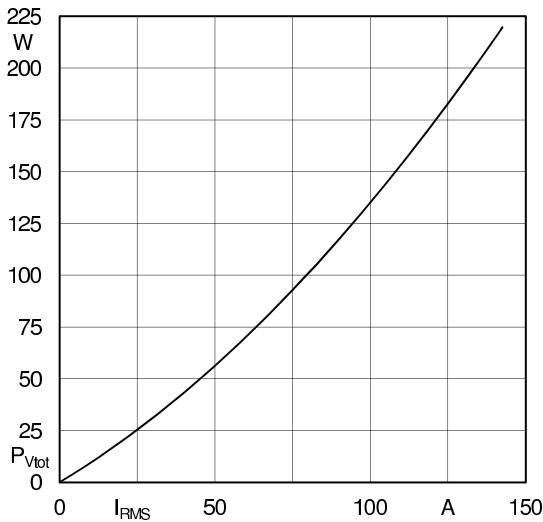

Fig. 2L: Max. power dissipation of one module vs. rms current

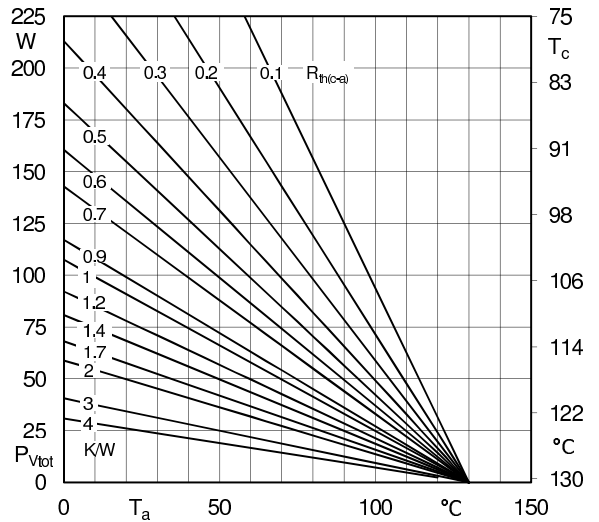

Fig. 2R: Max. power dissipation of one module vs. case temperature

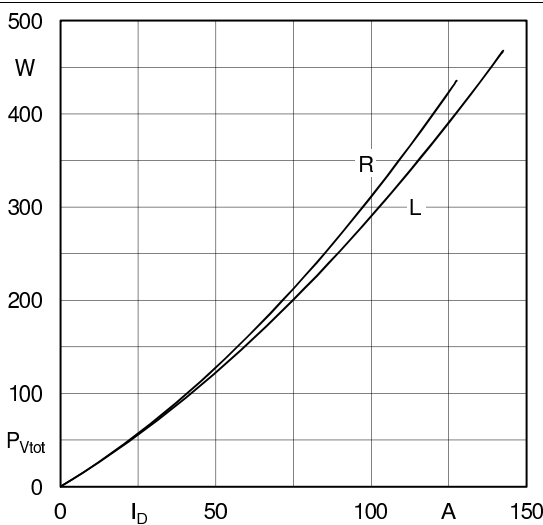

Fig. 3L: Max. power dissipation of two modules vs. direct current

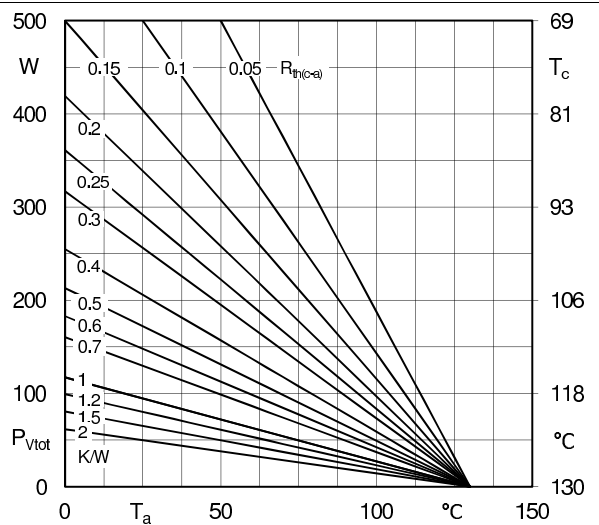

Fig. 3R: Max. power dissipation of two modules vs. case temperature

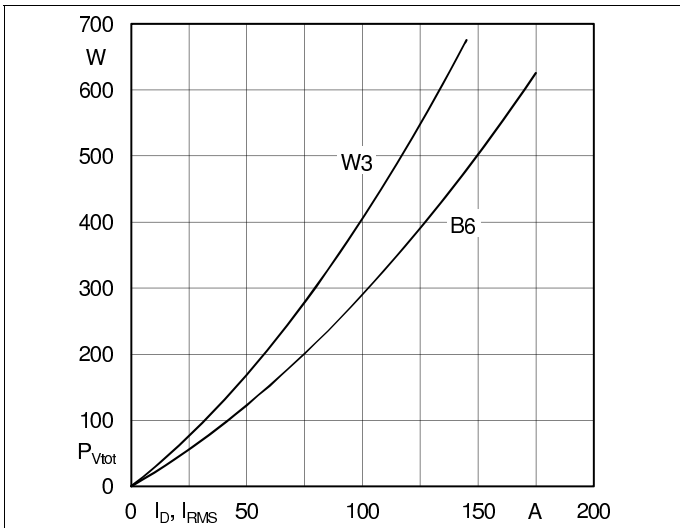

Fig. 4L: Max. power dissipation of three modules vs. direct current

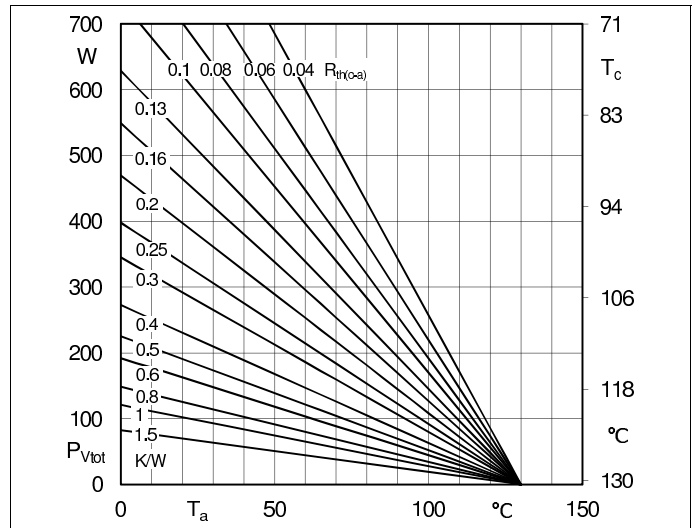

Fig. 4R: Max. power dissipation of three modules vs. case temperature

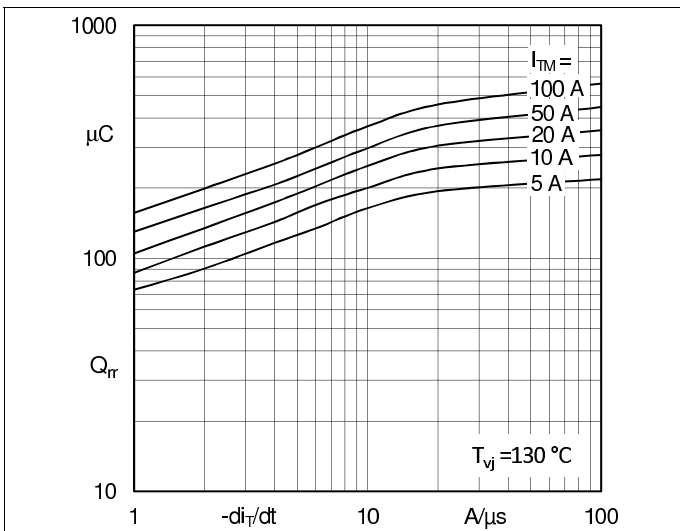

Fig. 5: Recovered charge vs. current decrease

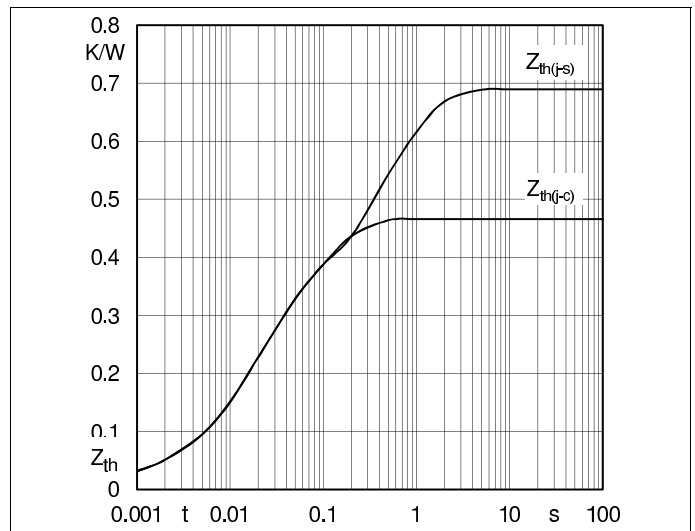

Fig. 6: Transient thermal impedance vs. time

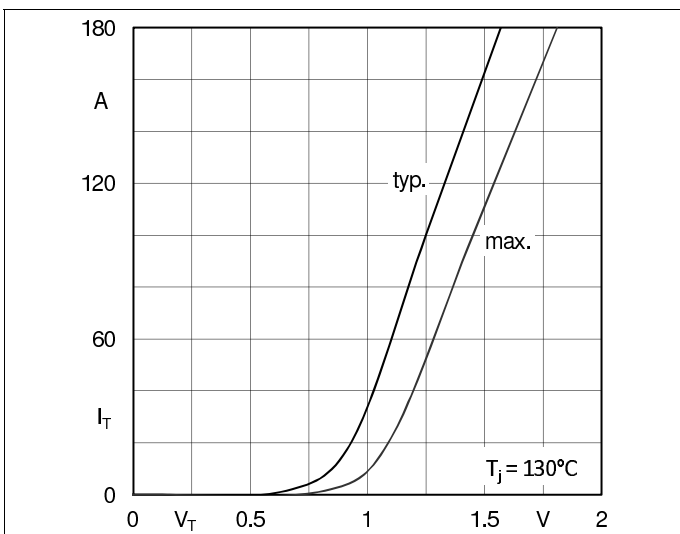

Fig. 7: On-state characteristics

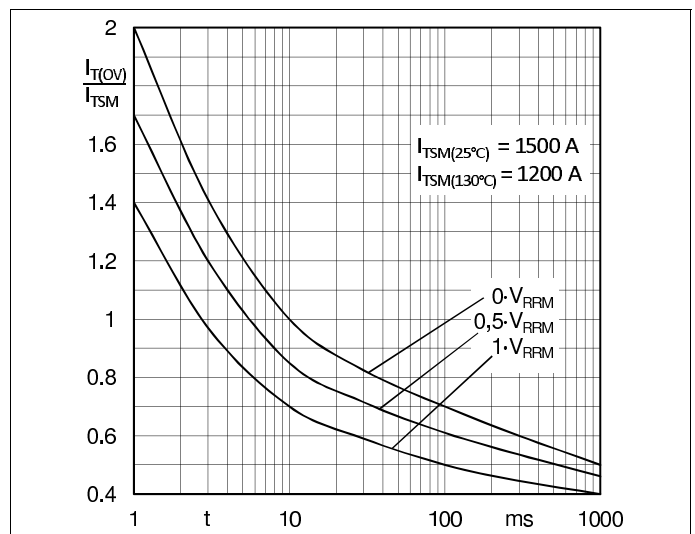

Fig. 8: Surge overload current vs. time

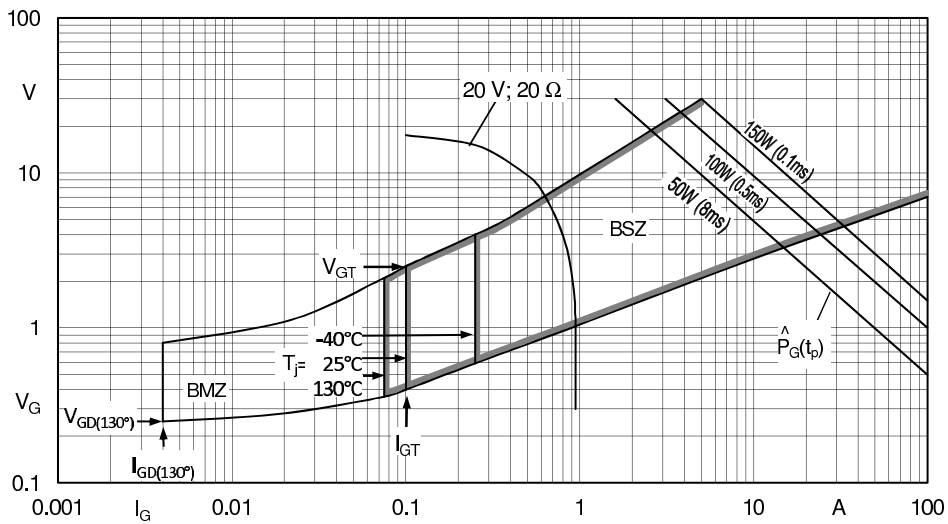
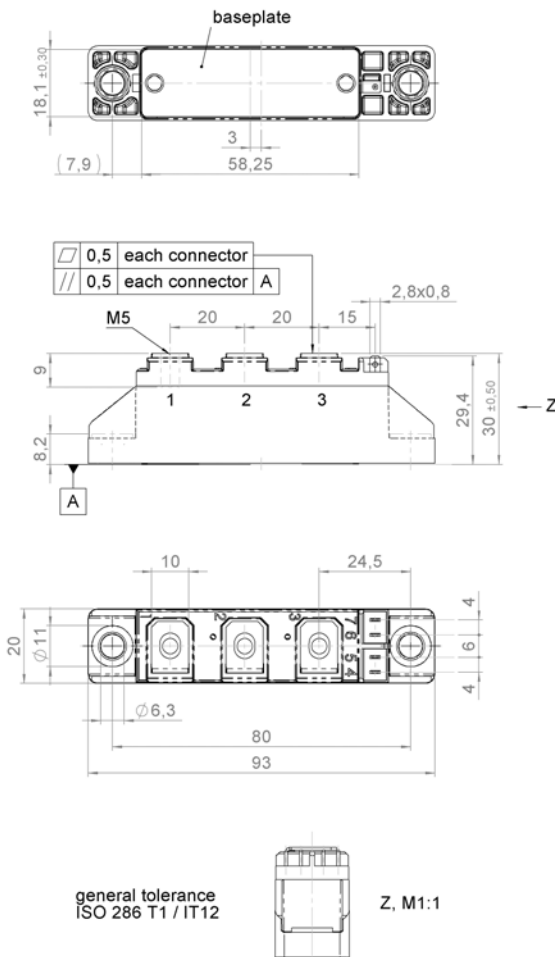
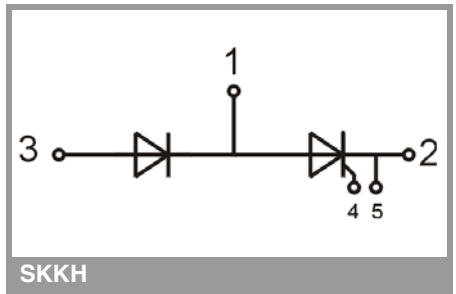

Fig. 9: Gate trigger characteristics



SEMIPACK 1



SKKH

This is an electrostatic discharge sensitive device (ESDS), international standard IEC 60747-1, Chapter IX

* The specifications of our components may not be considered as an assurance of component characteristics. Components have to be tested for the respective application. Adjustments may be necessary. The use of SEMIKRON products in life support appliances and systems is subject to prior specification and written approval by SEMIKRON. We therefore strongly recommend prior consultation of our staff.