

SKiIP 39TMLI12T4V2

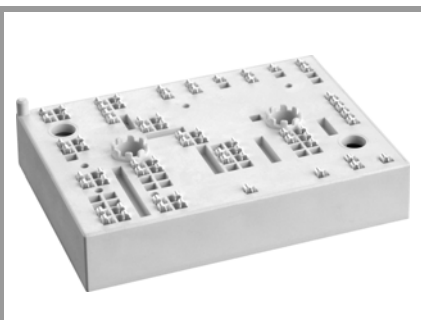

MiniSKiIP® 3

SKiIP 39TMLI12T4V2

Features*

- Robust and soft freewheeling diodes in CAL technology
- Highly reliable spring contacts for electrical connections
- UL recognised: File no. E63532

Remarks*

- Case temperature limited to $T_C = 125^\circ\text{C}$ max.; $T_C = T_S$ (valid for baseplateless modules)
- Product reliability results valid for $T_j \leq 150^\circ\text{C}$ (recommended $T_{op} = -40 \dots +150^\circ\text{C}$)
- IGBT 1: outer IGBTs T1&T4
- IGBT 2: inner IGBTs T2&T3
- Diode 1: outer diodes D1&D4
- Diode 2: inner diodes D2&D3
- $I_{t(RMS)} = 160\text{A}$ max. for power terminals

Absolute Maximum Ratings				
Symbol	Conditions	Values	Unit	
IGBT1				
V_{CES}	$T_j = 25^\circ\text{C}$	1200	V	
I_C	$\lambda_{paste}=0.8\text{ W/(mK)}$	$T_s = 25^\circ\text{C}$	235	A
	$T_j = 175^\circ\text{C}$	$T_s = 70^\circ\text{C}$	190	A
I_C	$\lambda_{paste}=2.5\text{ W/(mK)}$	$T_s = 25^\circ\text{C}$	289	A
	$T_j = 175^\circ\text{C}$	$T_s = 70^\circ\text{C}$	236	A
I_{Cnom}		200	A	
I_{CRM}		600	A	
V_{GES}		-20 ... 20	V	
t_{psc}	$V_{CC} = 800\text{ V}, V_{GE} \leq 15\text{ V}, T_j = 150^\circ\text{C}, V_{CES} \leq 1200\text{ V}$	6	μs	
T_j		-40 ... 175	$^\circ\text{C}$	
IGBT2				
V_{CES}	$T_j = 25^\circ\text{C}$	650	V	
I_C	$\lambda_{paste}=0.8\text{ W/(mK)}$	$T_s = 25^\circ\text{C}$	206	A
	$T_j = 175^\circ\text{C}$	$T_s = 70^\circ\text{C}$	165	A
I_C	$\lambda_{paste}=2.5\text{ W/(mK)}$	$T_s = 25^\circ\text{C}$	239	A
	$T_j = 175^\circ\text{C}$	$T_s = 70^\circ\text{C}$	192	A
I_{Cnom}		200	A	
I_{CRM}		600	A	
V_{GES}		-20 ... 20	V	
t_{psc}	$V_{CC} = 360\text{ V}, V_{GE} \leq 15\text{ V}, T_j = 150^\circ\text{C}, V_{CES} \leq 650\text{ V}$	6	μs	
T_j		-40 ... 175	$^\circ\text{C}$	
Diode1				
V_{RRM}	$T_j = 25^\circ\text{C}$	1200	V	
I_F	$\lambda_{paste}=0.8\text{ W/(mK)}$	$T_s = 25^\circ\text{C}$	194	A
	$T_j = 175^\circ\text{C}$	$T_s = 70^\circ\text{C}$	154	A
I_F	$\lambda_{paste}=2.5\text{ W/(mK)}$	$T_s = 25^\circ\text{C}$	224	A
	$T_j = 175^\circ\text{C}$	$T_s = 70^\circ\text{C}$	179	A
I_{FRM}		600	A	
I_{FSM}	10 ms, sin 180°, $T_j = 25^\circ\text{C}$	990	A	
T_j		-40 ... 175	$^\circ\text{C}$	
Diode2				
V_{RRM}	$T_j = 25^\circ\text{C}$	650	V	
I_F	$\lambda_{paste}=0.8\text{ W/(mK)}$	$T_s = 25^\circ\text{C}$	223	A
	$T_j = 175^\circ\text{C}$	$T_s = 70^\circ\text{C}$	174	A
I_F	$\lambda_{paste}=2.5\text{ W/(mK)}$	$T_s = 25^\circ\text{C}$	255	A
	$T_j = 175^\circ\text{C}$	$T_s = 70^\circ\text{C}$	200	A
I_{FRM}		400	A	
I_{FSM}	10 ms, sin 180°, $T_j = 25^\circ\text{C}$	1476	A	
T_j		-40 ... 175	$^\circ\text{C}$	
Module				
$I_{t(RMS)}$	20 A per spring	160	A	
T_{stg}	module without TIM	-40 ... 125	$^\circ\text{C}$	
V_{isol}	AC sinus 50 Hz, $t = 1\text{ min}$	2500	V	

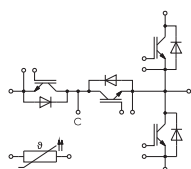

TMLI

SKiiP 39TMLI12T4V2

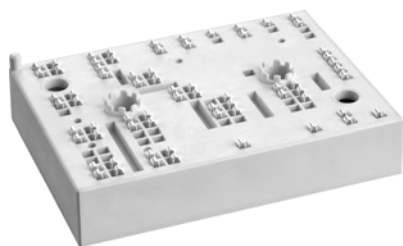

MiniSKiiP® 3

SKiiP 39TMLI12T4V2

Features*

- Robust and soft freewheeling diodes in CAL technology
- Highly reliable spring contacts for electrical connections
- UL recognised: File no. E63532

Remarks*

- Case temperature limited to $T_C = 125^\circ\text{C}$ max.; $T_C = T_S$ (valid for baseplateless modules)
- Product reliability results valid for $T_j \leq 150^\circ\text{C}$ (recommended $T_{op} = -40 \dots +150^\circ\text{C}$)
- IGBT 1: outer IGBTs T1&T4
- IGBT 2: inner IGBTs T2&T3
- Diode 1: outer diodes D1&D4
- Diode 2: inner diodes D2&D3
- $I_{t(RMS)} = 160\text{A}$ max. for power terminals

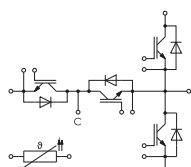

TMLI

Characteristics						
Symbol	Conditions		min.	typ.	max.	Unit
IGBT1						
$V_{CE(sat)}$	$I_C = 200\text{ A}$ $V_{GE} = 15\text{ V}$ chipllevel	$T_j = 25^\circ\text{C}$		1.80	2.05	V
		$T_j = 150^\circ\text{C}$		2.20	2.40	V
V_{CE0}	chipllevel	$T_j = 25^\circ\text{C}$		0.80	0.90	V
		$T_j = 150^\circ\text{C}$		0.70	0.80	V
r_{CE}	$V_{GE} = 15\text{ V}$ chipllevel	$T_j = 25^\circ\text{C}$		5.0	5.8	m Ω
		$T_j = 150^\circ\text{C}$		7.5	8.0	m Ω
$V_{GE(th)}$	$V_{GE} = V_{CE}, I_C = 12\text{ mA}$		5	5.8	6.5	V
I_{CES}	$V_{GE} = 0\text{ V}, V_{CE} = 1200\text{ V}, T_j = 25^\circ\text{C}$				2.0	mA
C_{ies}	$V_{CE} = 25\text{ V}$ $V_{GE} = 0\text{ V}$	$f = 1\text{ MHz}$		12.30		nF
C_{oes}		$f = 1\text{ MHz}$		0.81		nF
C_{res}		$f = 1\text{ MHz}$		0.69		nF
Q_G	$V_{GE} = -8\text{ V} \dots +15\text{ V}$			1130		nC
R_{Gint}	$T_j = 25^\circ\text{C}$			3.8		Ω
$t_{d(on)}$	$V_{CE} = 300\text{ V}$	$T_j = 150^\circ\text{C}$		186		ns
t_r	$I_C = 200\text{ A}$	$T_j = 150^\circ\text{C}$		80		ns
E_{on}	$V_{GE} = +15/-15\text{ V}$	$T_j = 150^\circ\text{C}$		7.5		mJ
$t_{d(off)}$	$R_{G on} = 1.5\ \Omega$	$T_j = 150^\circ\text{C}$		377		ns
t_f	$R_{G off} = 1.5\ \Omega$	$T_j = 150^\circ\text{C}$		109		ns
E_{off}	$di/dt_{on} = 2300\text{ A}/\mu\text{s}$ $di/dt_{off} = 1630\text{ A}/\mu\text{s}$	$T_j = 150^\circ\text{C}$		12.8		mJ
$R_{th(j-s)}$	per IGBT, $\lambda_{paste} = 0.8\text{ W}/(\text{mK})$			0.23		K/W
$R_{th(j-s)}$	per IGBT, $\lambda_{paste} = 2.5\text{ W}/(\text{mK})$			0.16		K/W
IGBT2						
$V_{CE(sat)}$	$I_C = 200\text{ A}$ $V_{GE} = 15\text{ V}$ chipllevel	$T_j = 25^\circ\text{C}$		1.45	1.85	V
		$T_j = 150^\circ\text{C}$		1.70	2.10	V
V_{CE0}	chipllevel	$T_j = 25^\circ\text{C}$		0.90	1.00	V
		$T_j = 150^\circ\text{C}$		0.82	0.90	V
r_{CE}	$V_{GE} = 15\text{ V}$ chipllevel	$T_j = 25^\circ\text{C}$		2.8	4.3	m Ω
		$T_j = 150^\circ\text{C}$		4.4	6.0	m Ω
$V_{GE(th)}$	$V_{GE} = V_{CE}, I_C = 3.2\text{ mA}$		5	5.8	6.5	V
I_{CES}	$V_{GE} = 0\text{ V}, V_{CE} = 650\text{ V}, T_j = 25^\circ\text{C}$				2.0	mA
C_{ies}	$V_{CE} = 25\text{ V}$ $V_{GE} = 0\text{ V}$	$f = 1\text{ MHz}$		12.32		nF
C_{oes}		$f = 1\text{ MHz}$		0.77		nF
C_{res}		$f = 1\text{ MHz}$		0.37		nF
Q_G	$V_{GE} = -8\text{ V} \dots +15\text{ V}$			1600		nC
R_{Gint}	$T_j = 25^\circ\text{C}$			1.0		Ω
$t_{d(on)}$	$V_{CE} = 300\text{ V}$	$T_j = 150^\circ\text{C}$		93		ns
t_r	$I_C = 200\text{ A}$	$T_j = 150^\circ\text{C}$		62		ns
E_{on}	$V_{GE} = +15/-15\text{ V}$	$T_j = 150^\circ\text{C}$		2		mJ
$t_{d(off)}$	$R_{G on} = 2\ \Omega$	$T_j = 150^\circ\text{C}$		295		ns
t_f	$R_{G off} = 2\ \Omega$	$T_j = 150^\circ\text{C}$		86		ns
E_{off}	$di/dt_{on} = 3300\text{ A}/\mu\text{s}$ $di/dt_{off} = 2200\text{ A}/\mu\text{s}$	$T_j = 150^\circ\text{C}$		9.3		mJ
$R_{th(j-s)}$	per IGBT, $\lambda_{paste} = 0.8\text{ W}/(\text{mK})$			0.33		K/W
$R_{th(j-s)}$	per IGBT, $\lambda_{paste} = 2.5\text{ W}/(\text{mK})$			0.26		K/W

SKiIP 39TMLI12T4V2

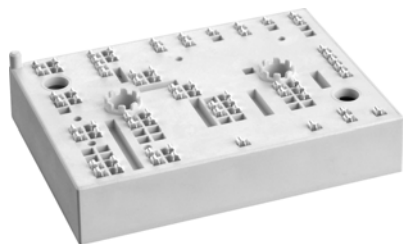

MiniSKiIP® 3

SKiIP 39TMLI12T4V2

Features*

- Robust and soft freewheeling diodes in CAL technology
- Highly reliable spring contacts for electrical connections
- UL recognised: File no. E63532

Remarks*

- Case temperature limited to $T_C = 125^\circ\text{C}$ max.; $T_C = T_S$ (valid for baseplateless modules)
- Product reliability results valid for $T_j \leq 150^\circ\text{C}$ (recommended $T_{op} = -40 \dots +150^\circ\text{C}$)
- IGBT 1: outer IGBTs T1&T4
- IGBT 2: inner IGBTs T2&T3
- Diode 1: outer diodes D1&D4
- Diode 2: inner diodes D2&D3
- $I_{t(RMS)} = 160\text{A}$ max. for power terminals

Characteristics						
Symbol	Conditions		min.	typ.	max.	Unit
Diode1						
$V_F = V_{EC}$	$I_F = 200\text{ A}$ $V_{GE} = 0\text{ V}$ chipllevel	$T_j = 25^\circ\text{C}$		2.20	2.52	V
		$T_j = 150^\circ\text{C}$		2.15	2.47	V
V_{F0}	chipllevel	$T_j = 25^\circ\text{C}$		1.30	1.50	V
		$T_j = 150^\circ\text{C}$		0.90	1.10	V
r_F	chipllevel	$T_j = 25^\circ\text{C}$		4.5	5.1	m Ω
		$T_j = 150^\circ\text{C}$		6.3	6.9	m Ω
I_{RRM}	$I_F = 200\text{ A}$	$T_j = 150^\circ\text{C}$		219		A
Q_{rr}	$di/dt_{off} = 3700\text{ A}/\mu\text{s}$ $V_R = 300\text{ V}$	$T_j = 150^\circ\text{C}$		31		μC
E_{rr}	$V_{GE} = +15/-15\text{ V}$	$T_j = 150^\circ\text{C}$		9.7		mJ
$R_{th(j-s)}$	per Diode, $\lambda_{paste} = 0.8\text{ W}/(\text{mK})$			0.34		K/W
$R_{th(j-s)}$	per Diode, $\lambda_{paste} = 2.5\text{ W}/(\text{mK})$			0.27		K/W
Diode2						
$V_F = V_{EC}$	$I_F = 200\text{ A}$ $V_{GE} = 0\text{ V}$ chipllevel	$T_j = 25^\circ\text{C}$		1.40	1.76	V
		$T_j = 150^\circ\text{C}$		1.38	1.77	V
V_{F0}	chipllevel	$T_j = 25^\circ\text{C}$		1.04	1.24	V
		$T_j = 150^\circ\text{C}$		0.85	0.99	V
r_F	chipllevel	$T_j = 25^\circ\text{C}$		1.78	2.6	m Ω
		$T_j = 150^\circ\text{C}$		2.7	3.9	m Ω
I_{RRM}	$I_F = 200\text{ A}$	$T_j = 150^\circ\text{C}$		154		A
Q_{rr}	$di/dt_{off} = 2200\text{ A}/\mu\text{s}$ $V_R = 300\text{ V}$	$T_j = 150^\circ\text{C}$		22.7		μC
E_{rr}	$V_{GE} = +15/-15\text{ V}$	$T_j = 150^\circ\text{C}$		5.5		mJ
$R_{th(j-s)}$	per Diode, $\lambda_{paste} = 0.8\text{ W}/(\text{mK})$			0.38		K/W
$R_{th(j-s)}$	per Diode, $\lambda_{paste} = 2.5\text{ W}/(\text{mK})$			0.31		K/W
Module						
L_{sCE1}				-		nH
L_{CE}				-		nH
$R_{CC'+EE'}$			$T_s = 25^\circ\text{C}$		-	m Ω
			$T_s = 125^\circ\text{C}$		-	m Ω
M_s	to heat sink		2		2.5	Nm
M_t					-	Nm
						Nm
w				82		g
Temperature Sensor						
R_{100}	$T_r = 100^\circ\text{C}$ ($R_{25} = 1000\Omega$)			1670 \pm 3%		Ω
$R_{(T)}$	$R_{(T)} = 1000\Omega[1 + A(T - 25^\circ\text{C}) + B(T - 25^\circ\text{C})^2]$ $A = 7.635 \cdot 10^{-3} \text{ }^\circ\text{C}^{-1}$, $B = 1.731 \cdot 10^{-5} \text{ }^\circ\text{C}^{-2}$					

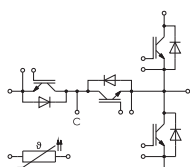

TMLI

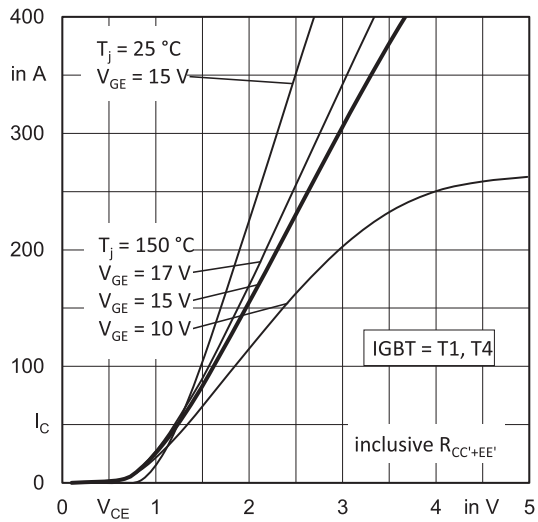

Fig. 1: Typ. output characteristic, inclusive $R_{CC'+EE'}$

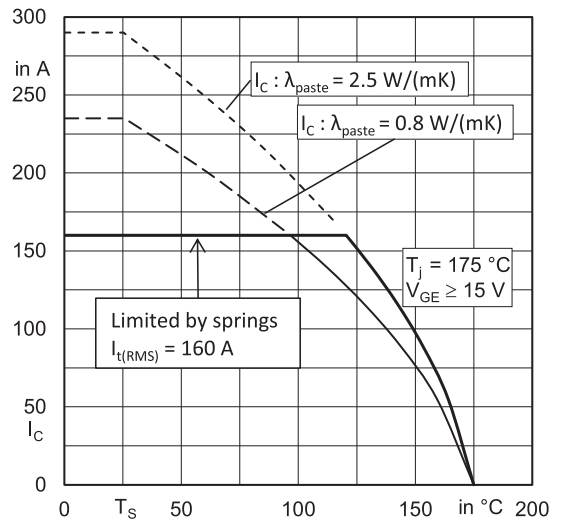

Fig. 2: IGBT1 rated current vs. Temperature $I_c=f(T_s)$

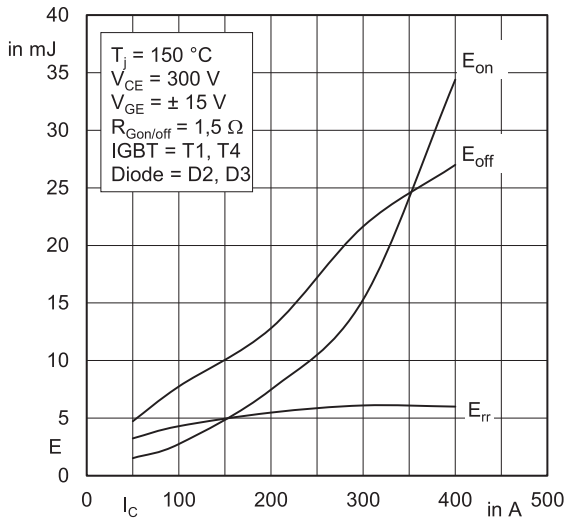

Fig. 3: Typ. IGBT1 & Diode2 turn-on /-off energy = $f(I_C)$

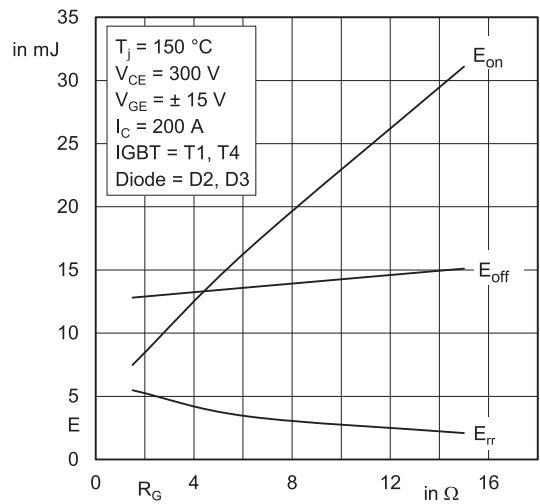

Fig. 4: Typ. IGBT1 & Diode2 turn-on /-off energy = $f(R_G)$

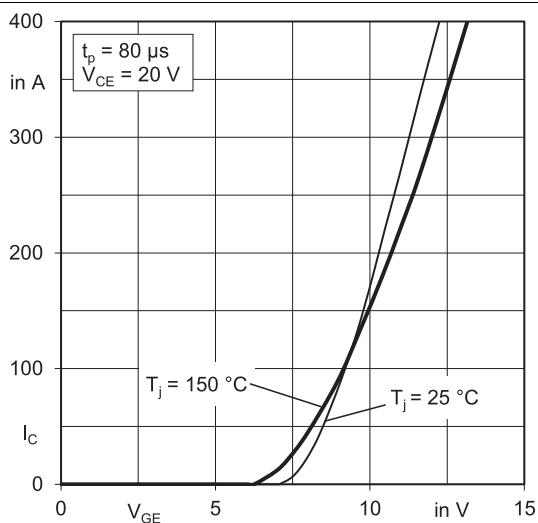

Fig. 5: Typ. IGBT1 transfer characteristic

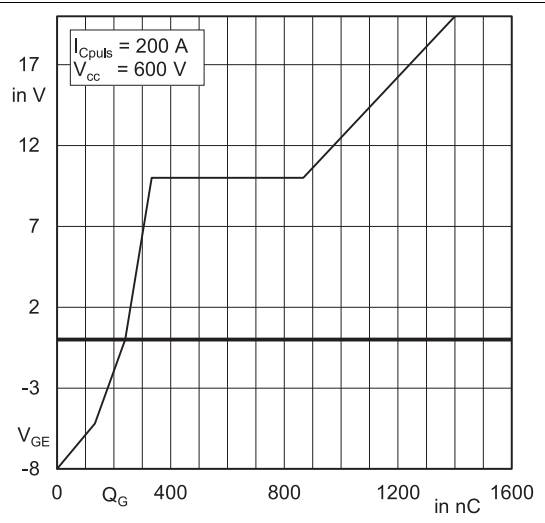
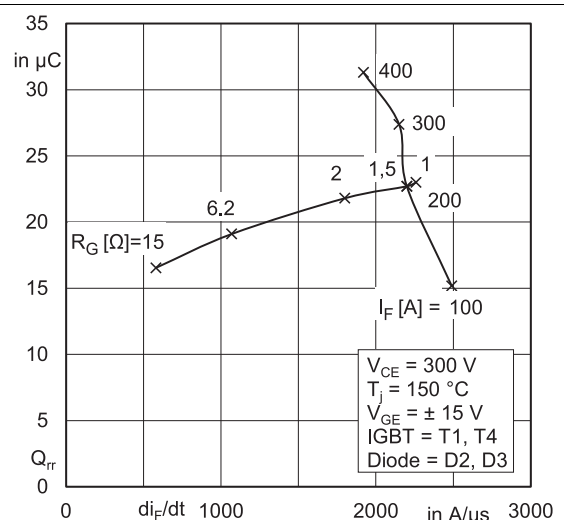
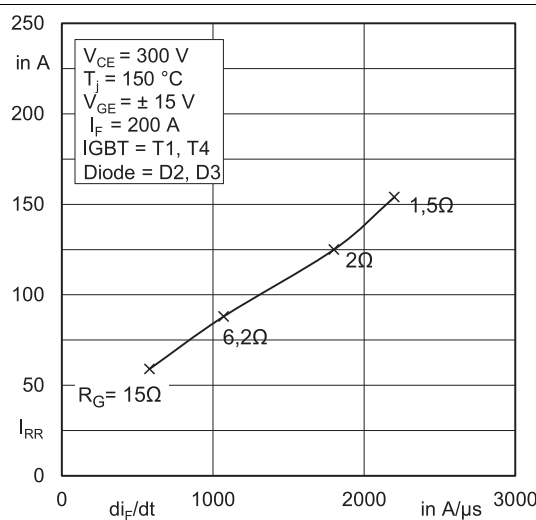
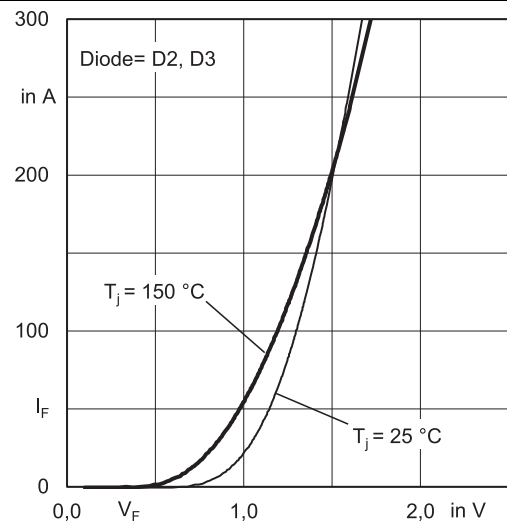
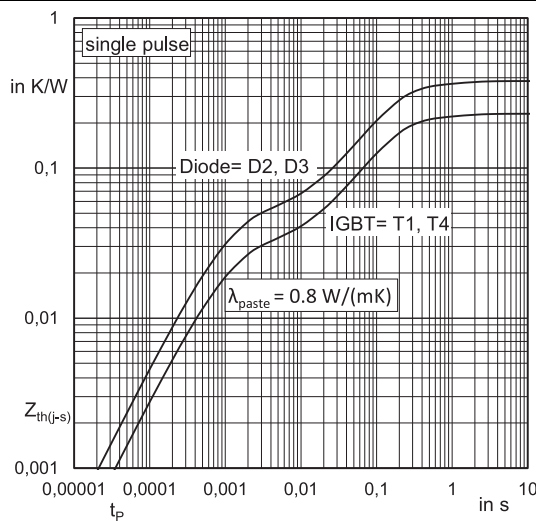
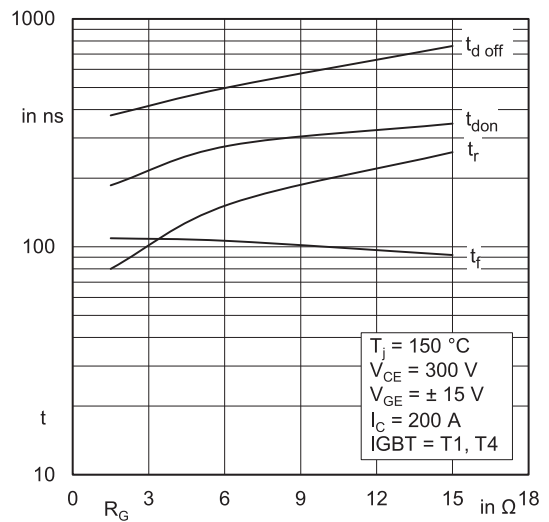
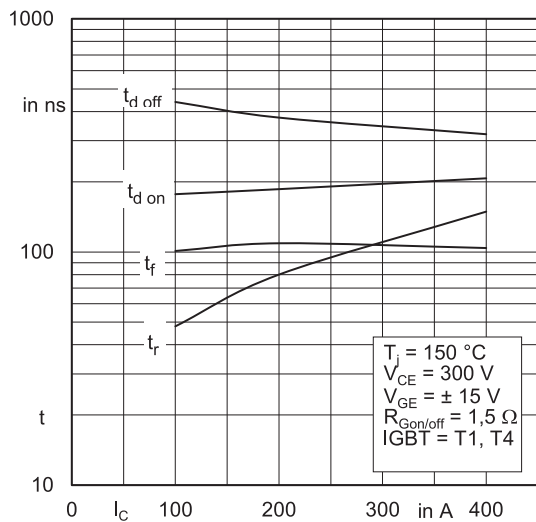

Fig. 6: Typ. IGBT1 gate charge characteristic



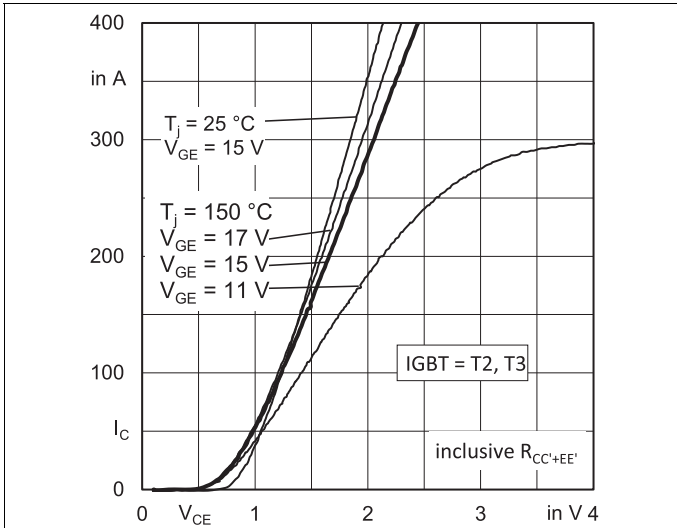

Fig. 13: Typ. IGBT2 output characteristic, incl. $R_{CC'+EE'}$

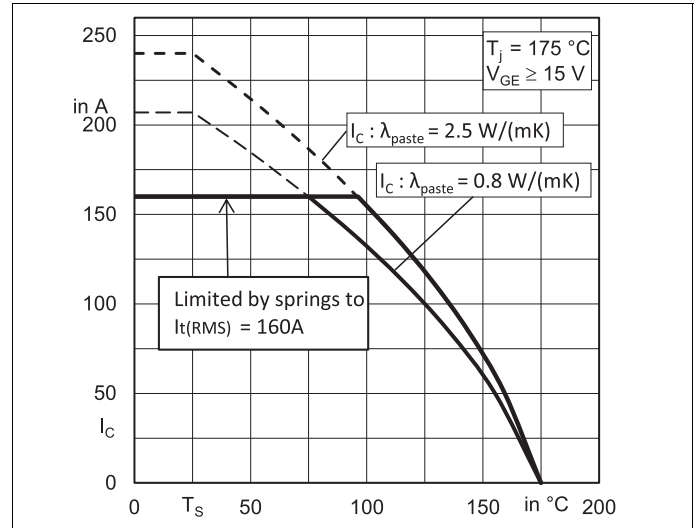

Fig. 14: Rated current vs. temperature $I_C = f(T_s)$

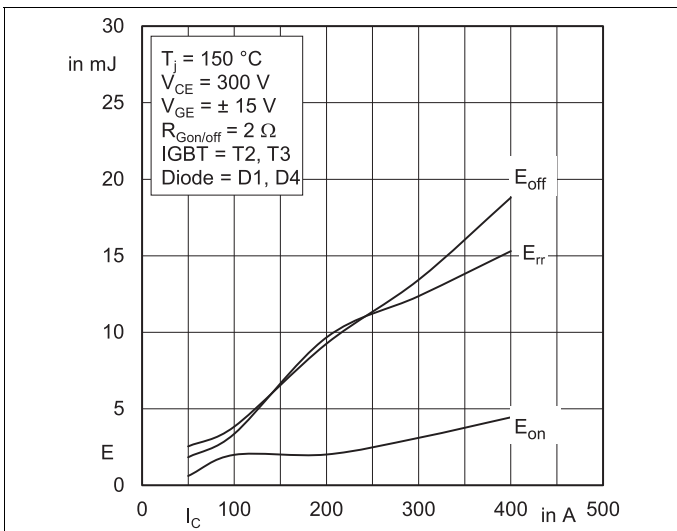

Fig. 15: Typ. IGBT2 & Diode1 turn-on /-off energy = $f(I_C)$

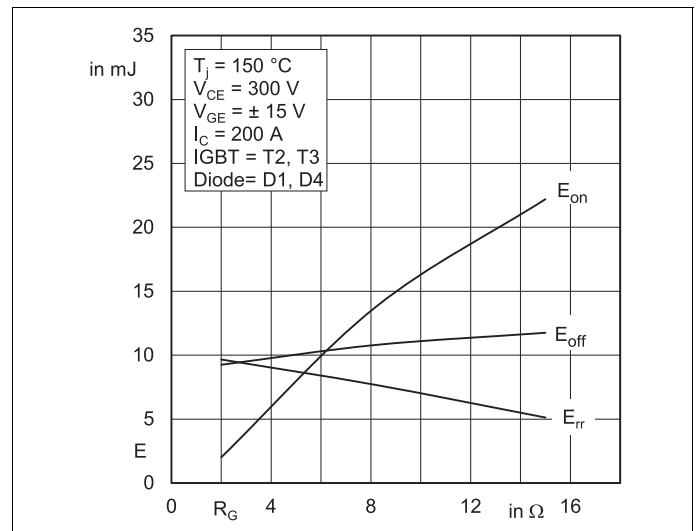

Fig. 16: Typ. IGBT2 & Diode1 turn-on /-off energy = $f(R_G)$

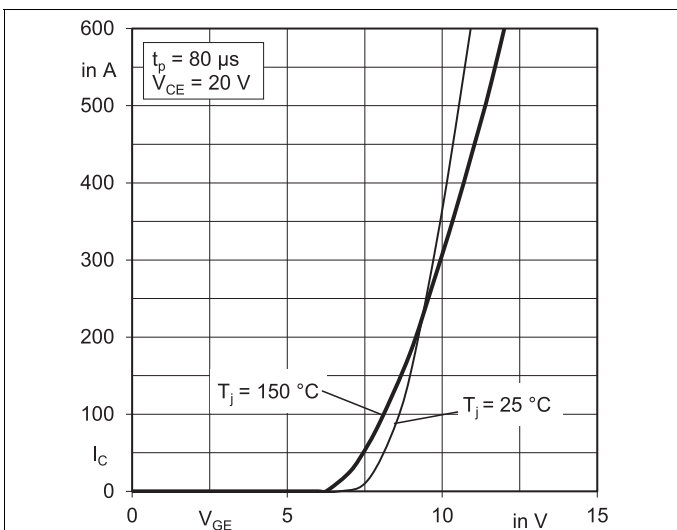

Fig. 17: Typ. IGBT2 transfer characteristic

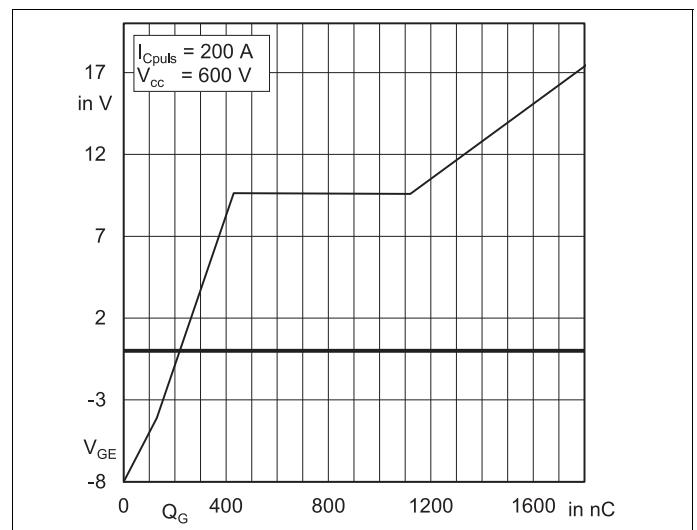

Fig. 18: Typ. IGBT2 gate charge characteristic

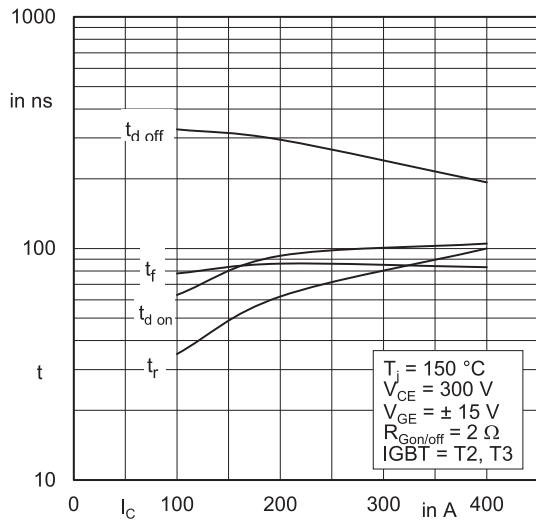

Fig. 19: Typ. IGBT2 switching times vs. I_C

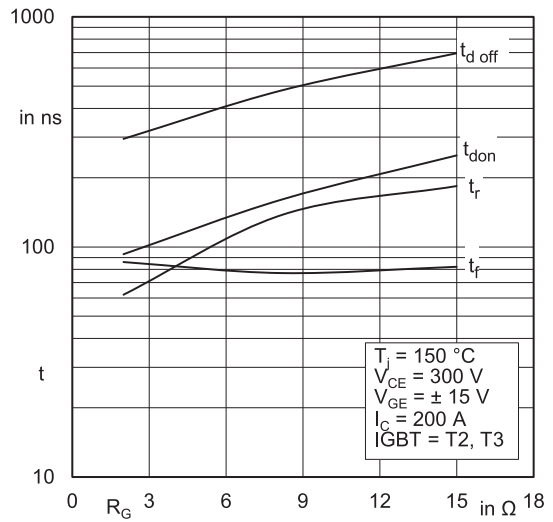

Fig. 20: Typ. IGBT2 switching times vs. gate resistor R_G

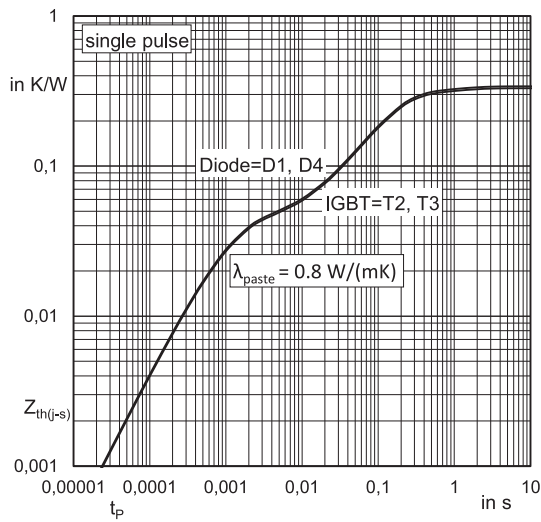

Fig. 21: Transient thermal impedance of IGBT2 & Diode1

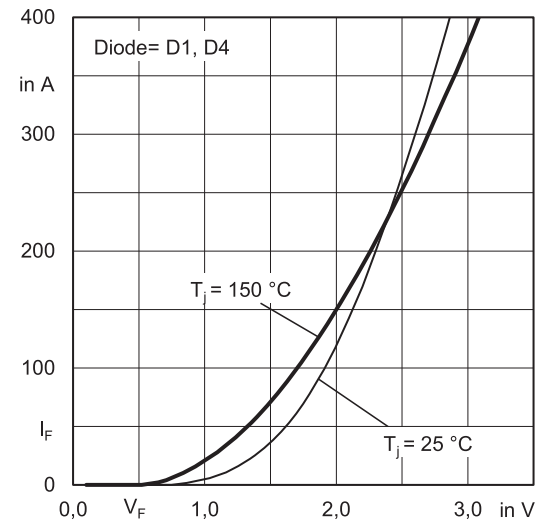

Fig. 22: Diode1 forward characteristic

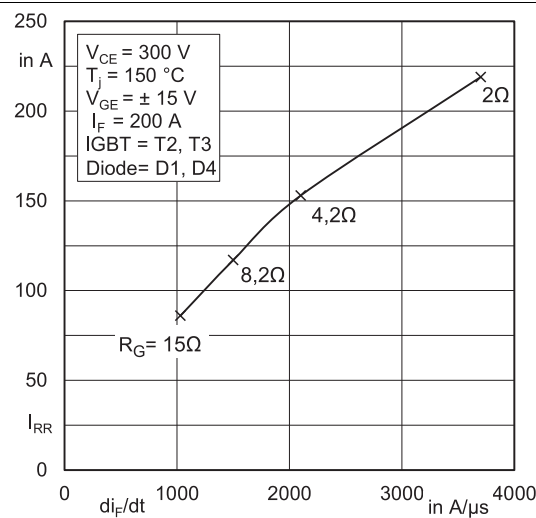

Fig. 23: Typ. Diode1 peak reverse recovery current

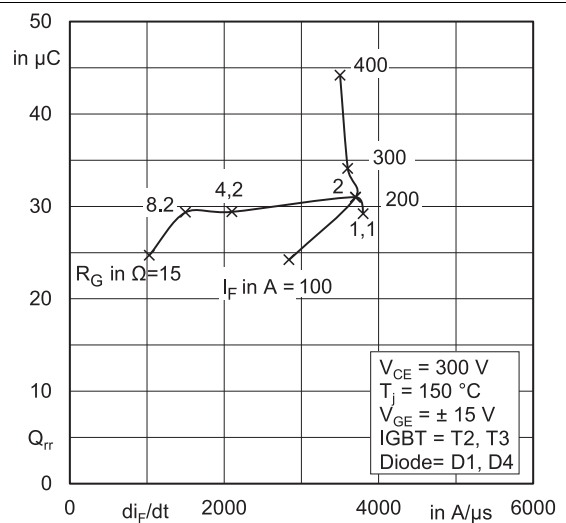
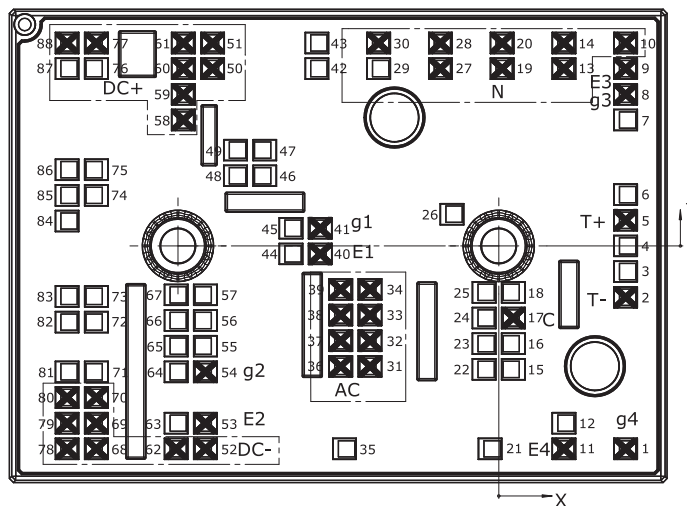

Fig. 24: Typ. Diode1 recovery charge

Pin out											
Pin	X	Y	Function	Pin	X	Y	Function	Pin	X	Y	Function
1	15,83	-25,30	g4	31	-16,05	-15,02	AC	61	-39,33	25,30	DC+
2	15,83	-6,40	-T	32	-16,05	-11,82	AC	62	-40,23	-25,30	DC-
3	15,83	-3,20		33	-16,05	-8,62	AC	63	-40,23	-22,10	
4	15,83	0		34	-16,05	-5,42	AC	64	-40,23	-15,70	
5	15,83	3,20	+T	35	-19,23	-25,30		65	-40,23	-12,50	
6	15,83	6,40		36	-19,70	-15,02	AC	66	-40,23	-9,30	
7	15,83	15,70		37	-19,70	-11,82	AC	67	-40,23	-6,10	
8	15,83	18,90	g3	38	-19,70	-8,62	AC	68	-50,18	-25,30	DC-
9	15,83	22,10	E3	39	-19,70	-5,42	AC	69	-50,18	-22,10	DC-
10	15,83	25,30	N	40	-22,26	-1,00	E1	70	-50,18	-15,70	DC-
11	8,13	-25,30	E4	41	-22,26	2,00	g1	71	-50,18	-12,50	
12	8,13	-22,10		42	-22,68	22,10		72	-50,18	-9,50	
13	8,13	22,10	N	43	-22,68	25,30		73	-50,18	-6,30	
14	8,13	25,30	N	44	-25,91	-1,00		74	-50,18	6,30	
15	1,83	-15,39		45	-25,91	2,00		75	-50,18	9,50	
16	1,83	-12,19		46	-29,18	8,74		76	-50,18	22,10	
17	1,83	-8,99	C	47	-29,18	11,94		77	-50,18	25,30	DC+
18	1,83	-5,79		48	-32,83	8,74		78	-53,83	-25,30	DC-
19	0,43	22,10	N	49	-32,83	11,94		79	-53,83	-22,10	DC-
20	0,43	25,30	N	50	-35,68	22,10	DC+	80	-53,83	-15,70	DC-
21	-1,08	-25,30		51	-35,68	25,30	DC+	81	-53,83	-12,50	
22	-1,83	-15,39		52	-36,58	-25,30	DC-	82	-53,83	-9,50	
23	-1,83	-12,19		53	-36,58	-22,10	E2	83	-53,83	-6,30	
24	-1,83	-8,99		54	-36,58	-15,70	g2	84	-53,83	3,10	
25	-1,83	-5,79		55	-36,58	-12,50		85	-53,83	6,30	
26	-5,83	3,95		56	-36,58	-9,30		86	-53,83	9,50	
27	-7,28	22,10	N	57	-36,58	-6,10		87	-53,83	22,10	
28	-7,28	25,30	N	58	-39,33	15,70	DC+	88	-53,83	25,30	DC+
29	-14,98	22,10		59	-39,33	18,90	DC+				
30	-14,98	25,30	N	60	-39,33	22,10	DC+				

all values in mm



Pinout and Dimensions

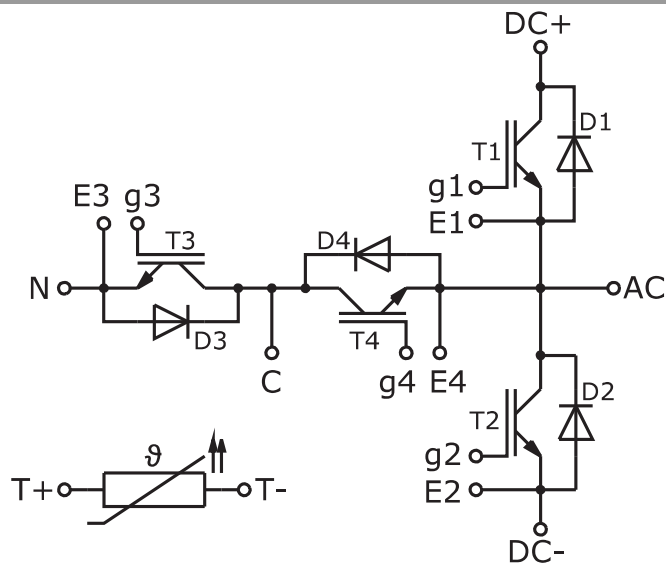

Pinout

This is an electrostatic discharge sensitive device (ESDS) due to international standard IEC 61340.

***IMPORTANT INFORMATION AND WARNINGS**

The specifications of SEMIKRON products may not be considered as guarantee or assurance of product characteristics ("Beschaffenheitsgarantie"). The specifications of SEMIKRON products describe only the usual characteristics of products to be expected in typical applications, which may still vary depending on the specific application. Therefore, products must be tested for the respective application in advance. Application adjustments may be necessary. The user of SEMIKRON products is responsible for the safety of their applications embedding SEMIKRON products and must take adequate safety measures to prevent the applications from causing a physical injury, fire or other problem if any of SEMIKRON products become faulty. The user is responsible to make sure that the application design is compliant with all applicable laws, regulations, norms and standards. Except as otherwise explicitly approved by SEMIKRON in a written document signed by authorized representatives of SEMIKRON, SEMIKRON products may not be used in any applications where a failure of the product or any consequences of the use thereof can reasonably be expected to result in personal injury. No representation or warranty is given and no liability is assumed with respect to the accuracy, completeness and/or use of any information herein, including without limitation, warranties of non-infringement of intellectual property rights of any third party. SEMIKRON does not assume any liability arising out of the applications or use of any product; neither does it convey any license under its patent rights, copyrights, trade secrets or other intellectual property rights, nor the rights of others. SEMIKRON makes no representation or warranty of non-infringement or alleged non-infringement of intellectual property rights of any third party which may arise from applications. Due to technical requirements our products may contain dangerous substances. For information on the types in question please contact the nearest SEMIKRON sales office. This document supersedes and replaces all information previously supplied and may be superseded by updates. SEMIKRON reserves the right to make changes.