

SKiiP 83 AHB 15

Absolute Maximum Ratings		Values	Units
Symbol	Conditions ¹⁾		
Bridge Rectifier			
V_{RRM}		1500	V
I_D	$T_{heatsink} = 80\text{ °C}$	125	A
I_{FSM}/I_{TSM}	$t_p = 10\text{ ms}; \sin. 180\text{ °C}, T_j = 25\text{ °C}$	1000	A
$I_{\Delta t}$	$t_p = 10\text{ ms}; \sin. 180\text{ °C}, T_j = 25\text{ °C}$	5000	A ² s
IGBT Chopper			
V_{CES}		1200	V
V_{GES}		± 20	V
I_C	$T_{heatsink} = 25 / 80\text{ °C}$	95 / 65	A
I_{CM}	$t_p < 1\text{ ms}; T_{heatsink} = 25 / 80\text{ °C}$	190 / 130	A
Freewheeling Diode ²⁾			
V_{RRM}		1200	V
I_F	$T_{heatsink} = 25 / 80\text{ °C}$	38 / 26	A
I_{FM}	$t_p < 1\text{ ms}; T_{heatsink} = 25 / 80\text{ °C}$	76 / 52	A
T_j	Diode & IGBT	- 40 ... + 150	°C
T_j	Thyristor	- 40 ... + 125	°C
T_{stg}		- 40 ... + 125	°C
V_{isol}	AC, 1 min.	2500	V

Characteristics		min.	typ.	max.	Units
Symbol	Conditions ¹⁾				
Diode - Rectifier					
V_F	$I_F = 100\text{ A}, T_j = 125\text{ °C}$	-	1,15	-	V
V_{TO}	$T_j = 125\text{ °C}$	-	0,8	-	V
r_T	$T_j = 125\text{ °C}$	-	3,5	-	mΩ
R_{thjh}	per diode	-	-	0,7	K/W
Thyristor - Rectifier					
V_T	$I_F = 120\text{ A}, T_j = 25\text{ °C}$	-	-	1,8	V
$V_T (TO)$	$T_j = 125\text{ °C}$	-	-	1,1	V
r_T	$T_j = 125\text{ °C}$	-	-	5	mΩ
R_{thjh}	per thyristor	-	-	0,9	K/W
I_{GD}	$T_j = 125\text{ °C}$	5	-	-	mA
V_{GT}	$T_j = 25\text{ °C}$	-	-	3	V
I_{GT}		-	-	150	mA
I_H	$T_j = 25\text{ °C}$	-	250	-	mA
I_L		-	600	-	mA
dv/dt_{CR}	$T_j = 125\text{ °C}$	500	-	-	V/μs
di/dt_{CR}		-	-	125	A/μs
IGBT - Chopper					
V_{CEsat}	$I_C = 75\text{ A}, T_j = 25 (125)\text{ °C}$	-	2,5(3,1)	3,0(3,7)	V
$t_{d(on)}$	$V_{CC} = 600\text{ V}; V_{GE} = \pm 15\text{ V}$ $I_C = 75\text{ A}; T_j = 125\text{ °C}$	-	35	70	ns
t_r		-	70	140	ns
$t_{d(off)}$	$R_{gon} = R_{goff} = 15\text{ Ω}$ inductive load	-	450	600	ns
t_f		-	70	100	ns
$E_{on} + E_{off}$	$V_{CE} = 25\text{ V}; V_{GE} = 0\text{ V}, 1\text{ MHz}$	-	18	-	mJ
C_{ies}		-	5,0	-	nF
R_{thjh}		per IGBT	-	-	0,35

MiniSKiiP 8 SEMIKRON integrated intelligent Power SKiiP 83 AHB 15 half controlled 3-phase bridge rectifier + IGBT braking chopper

Case M8a

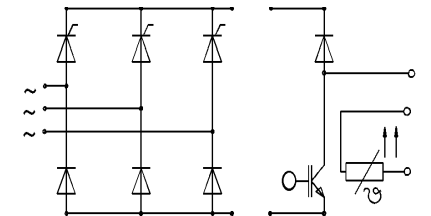
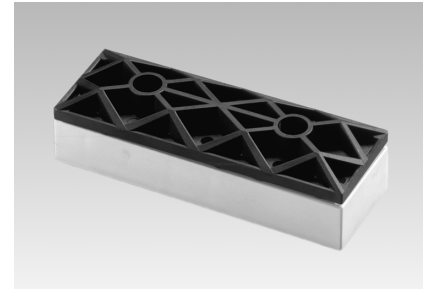

UL recognized file no. E63532

- specification of temperature sensor see part A
- common characteristics see page B 16 – 4

Options

- also available with uncontrolled rectifier (called 83 ANB 15)
- also available with powerful chopper, for characteristics please refer to SKiiP 83 AC 12
- also available with full controlled rectifier (called 83 ATB 15)

¹⁾ $T_{heatsink} = 25\text{ °C}$, unless otherwise specified
²⁾ CAL = Controlled Axial Lifetime Technology (soft and fast recovery)

MiniSKiiP 8
SEMIKRON integrated
intelligent Power
SKiiP 83 AHB 15
half controlled
3-phase bridge rectifier +
IGBT braking chopper

Case M8a

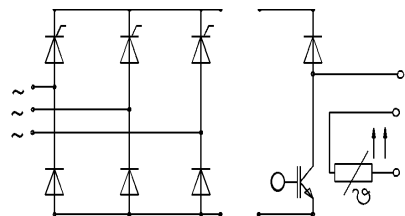
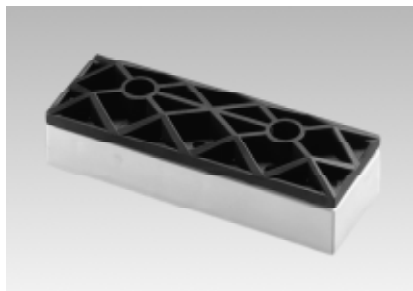

SKiiP 83 AHB 15

Characteristics		min.	typ.	max.	Units
Symbol	Conditions ¹⁾				
Diode ²⁾ - Freewheeling					
$V_F = V_{EC}$	$I_F = 25 \text{ A}$ $T_j = 25 (125) \text{ }^\circ\text{C}$	–	2,0(1,8)	2,5(2,3)	V
V_{TO}	$T_j = 125 \text{ }^\circ\text{C}$	–	1,0	1,2	V
r_T	$T_j = 125 \text{ }^\circ\text{C}$	–	32	44	m Ω
I_{RRM}	$I_F = 25 \text{ A}; V_R = -600 \text{ V}$ $di_F/dt = -500 \text{ A}/\mu\text{s}$ $V_{GE} = 0 \text{ V}, T_j = 125 \text{ }^\circ\text{C}$	–	25	–	A
Q_{rr}		–	4,5	–	μC
E_{off}		–	1,0	–	mJ
R_{thjh}		per diode	–	–	1,2
Temperature Sensor					
R_{TS}	$T = 25 / 100 \text{ }^\circ\text{C}$		1000 / 1670		Ω
Mechanical Data					
M_1	case to heatsink, SI Units	2,5	–	3,5	Nm
Case	mechanical outline see pages B 16 –13 and B 16 – 14		M8a		

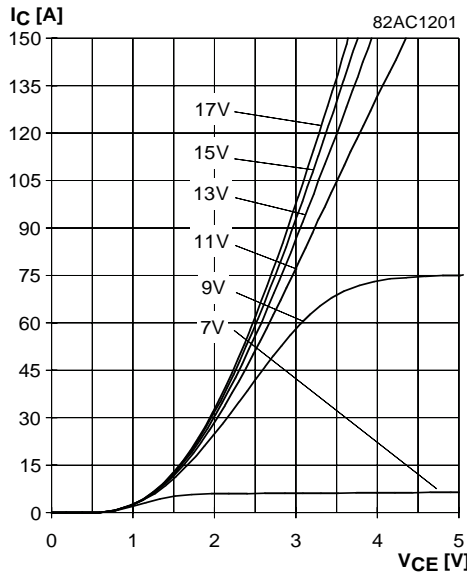

Fig. 1 Typ. output characteristic, $t_p = 80 \mu s$; $25 \text{ }^\circ\text{C}$

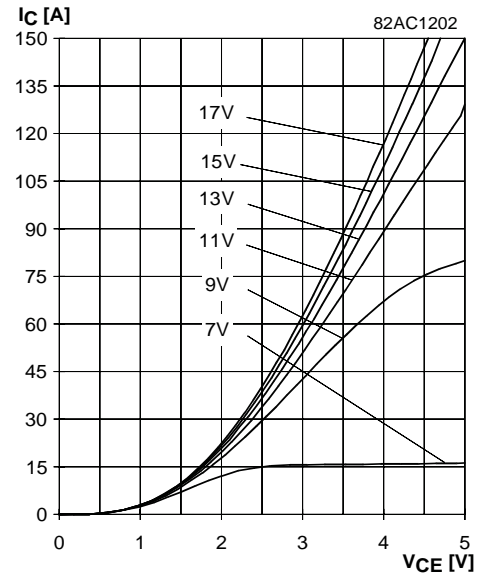

Fig. 2 Typ. output characteristic, $t_p = 80 \mu s$; $125 \text{ }^\circ\text{C}$

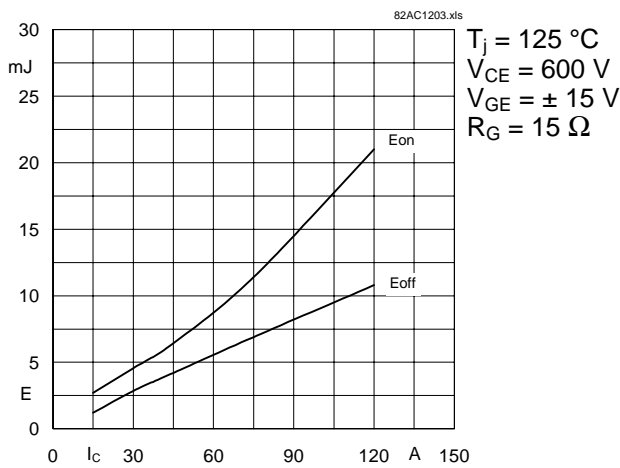

Fig. 3 Turn-on /-off energy = $f(I_c)$

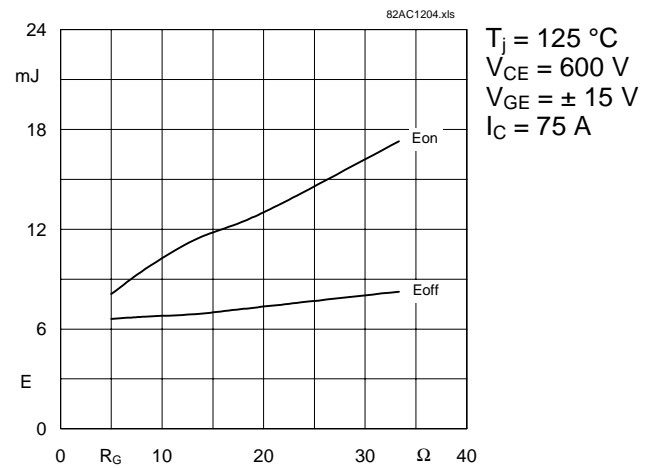

Fig. 4 Turn-on /-off energy = $f(R_G)$

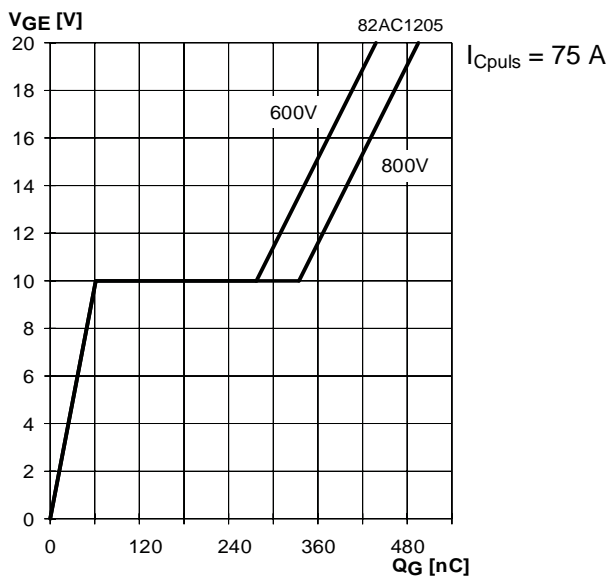

Fig. 5 Typ. gate charge characteristic

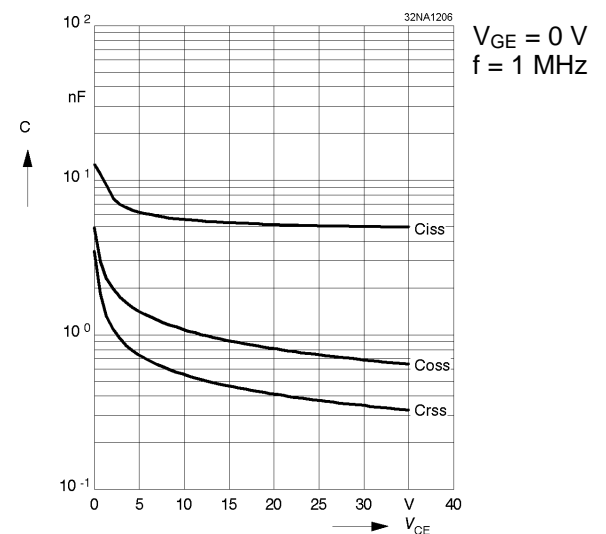

Fig. 6 Typ. capacitances vs. V_{CE}

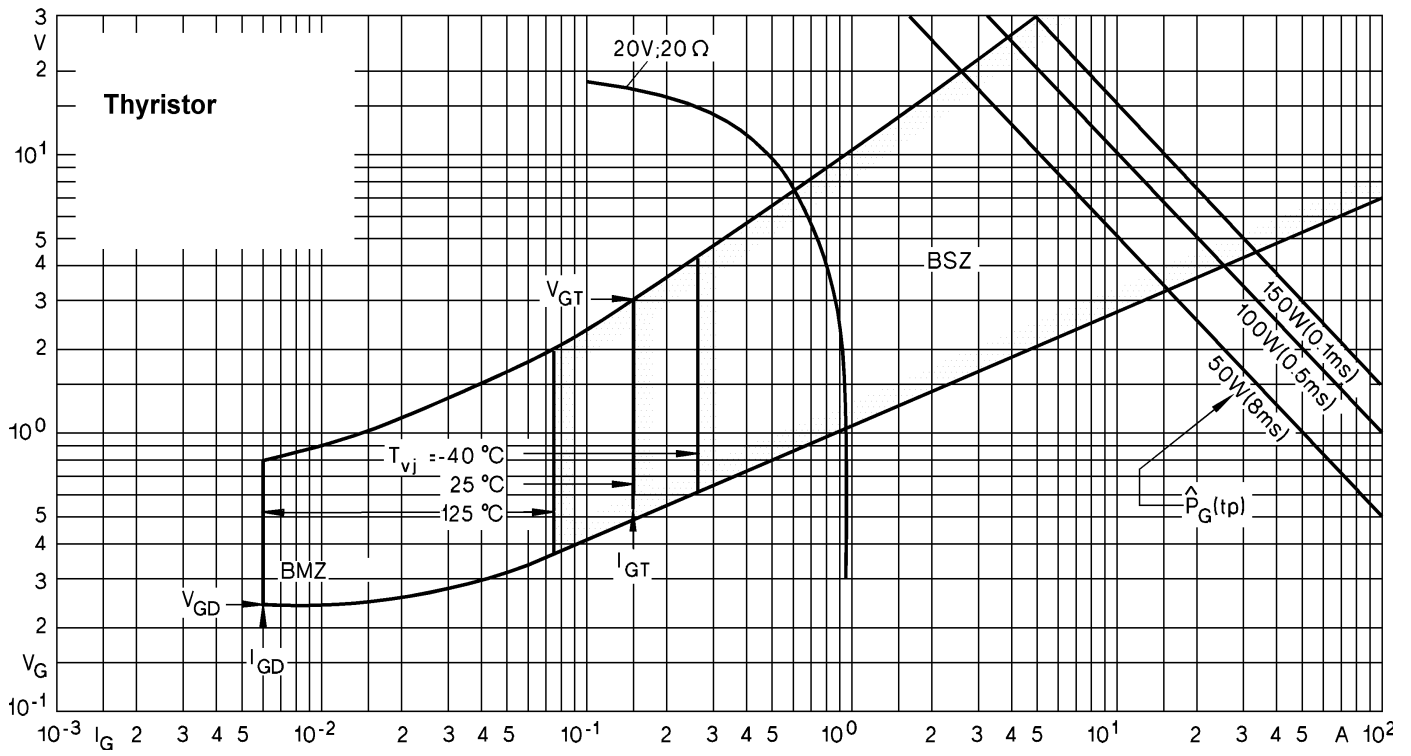

Fig. 7 Gate trigger characteristics

MiniSKiiP 1200 V

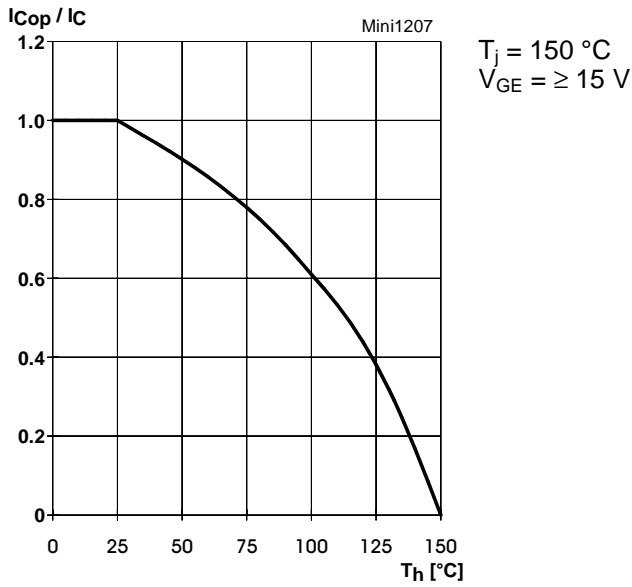

Fig. 7 Rated current of the IGBT $I_{COp} / I_C = f(T_h)$

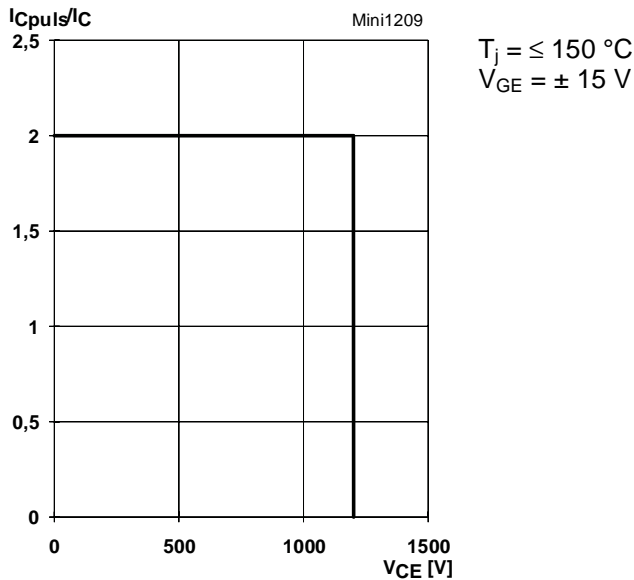

Fig. 9 Turn-off safe operating area (RBSOA) of the IGBT

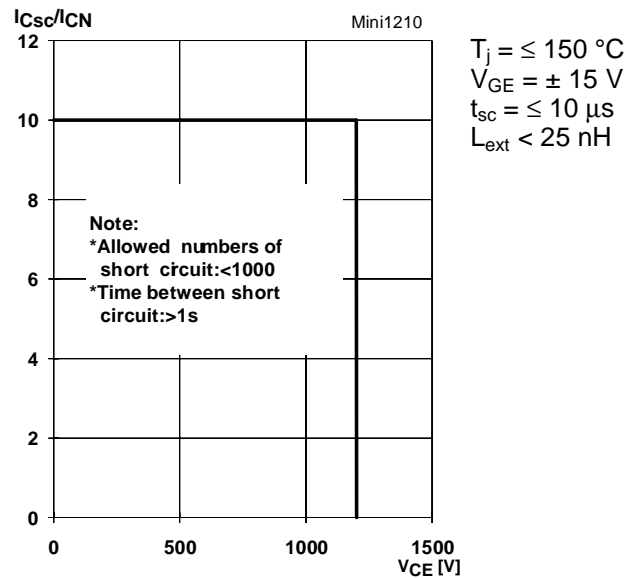

Fig. 10 Safe operating area at short circuit of the IGBT

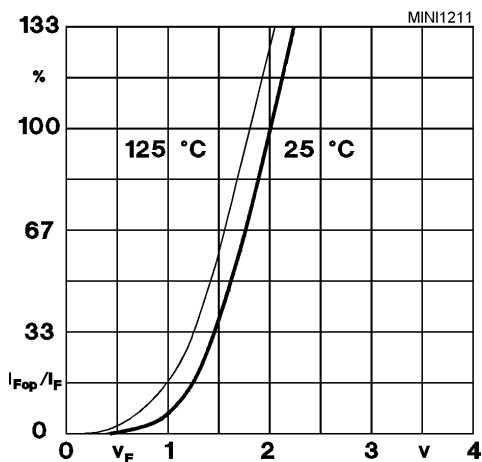

Fig. 11 Typ. freewheeling diode forward characteristic

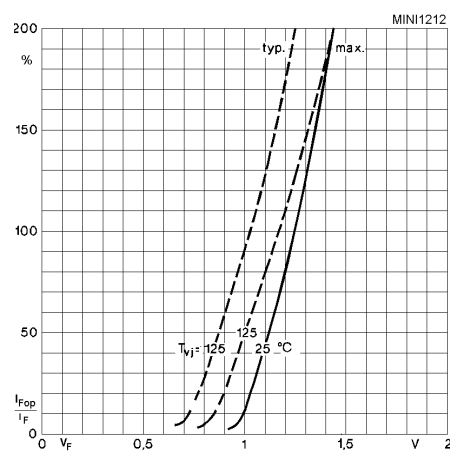

Fig. 12 Forward characteristic of the input bridge diode

MiniSKiiP 8

Input bridge part

- SKiiP 82 ANB 08
- SKiiP 83 ANB 08
- SKiiP 81 ANB 15
- SKiiP 82 ANB 15
- SKiiP 83 ANB 15
- SKiiP 83 AHB 15
- SKiiP 83 ATB 15

Circuit ANB
Case M8a

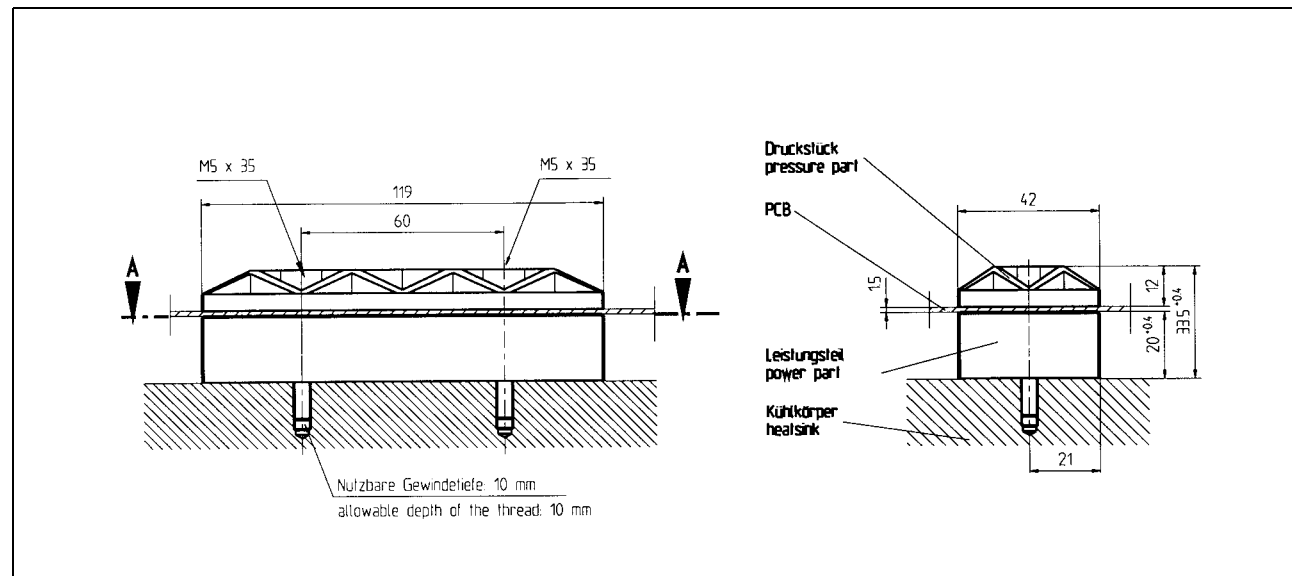
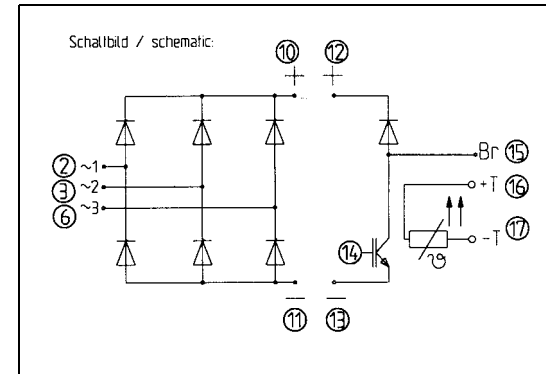

MiniSKiiP 8

Input bridge part

SKiiP 82 ANB 08
 SKiiP 83 ANB 08
 SKiiP 81 ANB 15
 SKiiP 82 ANB 15
 SKiiP 83 ANB 15
 SKiiP 83 AHB 15
 SKiiP 83 ATB 15

Case M8a
 Layout and connections for the
 customer's printed circuit board

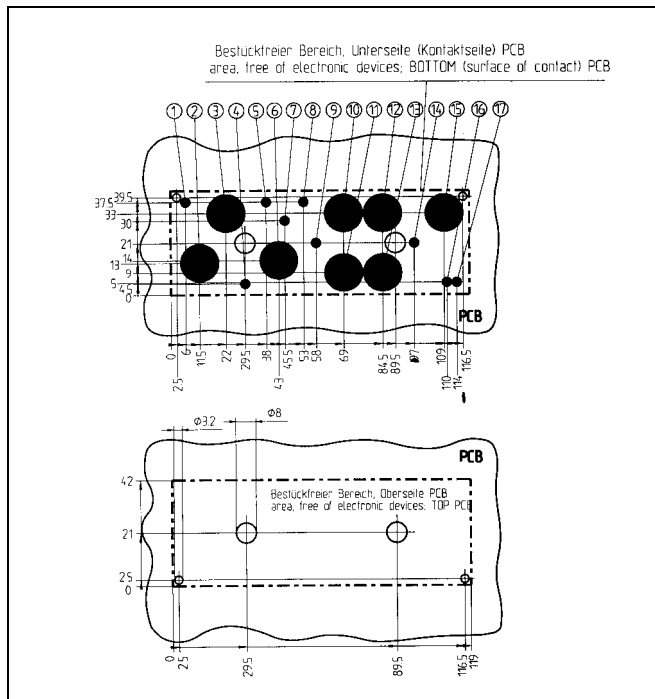

Circuit AHB

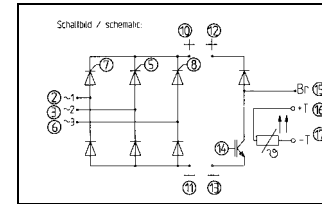

Circuit ATB

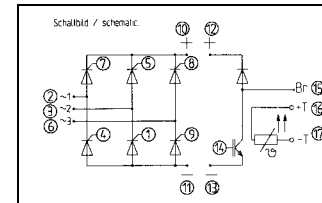

Pin	Connection			
	Diode bridge ANB	Halfcontrolled AHB	Thyristor bridge ATB	
1	reserved	reserved		G2 Bot
2	~ 1	~ 1	~ 1	
3	~ 2	~ 2	~ 2	
4	reserved	reserved		G1 Bot
5	reserved	G2 Top		G2 Top
6	~ 3	~ 3	~ 3	
7	reserved	G1 Top		G1 Top
8	reserved	G3 Top		G3 Top
9	reserved	reserved		G3 Bot
10	+	+	+	
11	-	-	-	
12	+	+	+	
13	-	-	-	
14	Gate Br	Gate Br	Gate Br	Gate Br
15	Br	Br	Br	
16	T +	T +	T +	
17	T -	T -	T -	