

**SEMITOP<sup>®</sup> 2**

## MOSFET Module

**SK70MD075**

Target Data

### Features

- Compact design
- One screw mounting
- Heat transfer and isolation through direct copper bonding aluminium oxide ceramic (DBC)
- Trench-gate technology
- Short internal connections and low inductance case

### Typical Applications

- Low switched mode power supplies
- DC servo drives
- UPS
- Electric Vehicles drives

1) Maximum PCB temperature, at pins contact, = 85°C

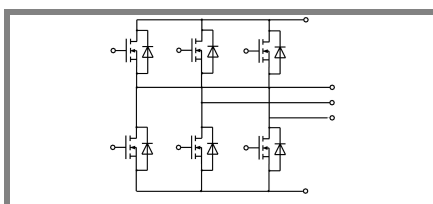

**MD**

Absolute Maximum Ratings		$T_s = 25\text{ °C}$ , unless otherwise specified	
Symbol	Conditions	Values	Units
<b>MOSFET</b>			
$V_{DSS}$		75	V
$V_{GSS}$		$\pm 20$	V
$I_D$	$T_s = 25\text{ (80) °C}; 1$	100 (70)	A
$I_{DM}$	$t_p < 1\text{ ms}; T_s = 80\text{ (80) °C}; 1$	(140)	A
$T_j$		- 40 ... + 150	°C
<b>Inverse diode</b>			
$I_F = -I_D$	$T_s = 25\text{ (80) °C};$	100 (70)	A
$I_{FM} = -I_{DM}$	$t_p < 1\text{ ms}; T_s = 80\text{ (80) °C};$	(140)	A
$T_j$		- 40 ... + 150	°C
<b>Freewheeling CAL diode</b>			
$I_F = -I_D$	$T_s = \text{°C}$		A
$T_j$			°C
$T_{stg}$		- 40 ... + 125	°C
$T_{sol}$	Terminals, 10 s	260	°C
$V_{isol}$	AC, 1 min	2500 / 3000	V

Characteristics		$T_s = 25\text{ °C}$ , unless otherwise specified			
Symbol	Conditions	min.	typ.	max.	Units
<b>MOSFET</b>					
$V_{(BR)DSS}$	$V_{GS} = 0\text{ V}; I_D = 5,6\text{ mA}$	75			V
$V_{GS(th)}$	$V_{GS} = V_{DS}; I_D = 5,6\text{ mA}$	2,5	3,3		V
$I_{DSS}$	$V_{GS} = 0\text{ V}; V_{DS} = V_{DSS}; T_j = 25\text{ °C}$			100	$\mu\text{A}$
$I_{GSS}$	$V_{GS} = \pm 20\text{ V}; V_{DS} = 0\text{ V}$			100	nA
$R_{DS(on)}$	$I_D = 80\text{ A}; V_{GS} = 10\text{ V}; T_j = 25\text{ °C}$			5	m $\Omega$
$R_{DS(on)}$	$I_D = 80\text{ A}; V_{GS} = 10\text{ V}; T_j = 125\text{ °C}$			10	m $\Omega$
$C_{CHC}$	per MOSFET				pF
$C_{iss}$	under following conditions:		7		nF
$C_{oss}$	$V_{GS} = 0\text{ V}; V_{DS} = 25\text{ V}; f = 1\text{ MHz}$		1,5		nF
$C_{rss}$					nF
$L_{DS}$					nH
$t_{d(on)}$	under following conditions:				ns
$t_r$	$V_{DD} = 50\text{ V}; V_{GS} = 10\text{ V};$ $I_D = 50\text{ A}$				ns
$t_{d(off)}$	$R_G = 56\text{ }\Omega$				ns
$t_f$					ns
$R_{th(j-s)}$	per MOSFET (per module)			1,1	K/W
<b>Inverse diode</b>					
$V_{SD}$	$I_F = 50\text{ A}; V_{GS} = 0\text{ V}; T_j = 50\text{ °C}$		0,9		V
$I_{RRM}$	under following conditions:				A
$Q_{rr}$	$I_F = 50\text{ A}; T_{vj} = 25\text{ °C}; R_G = 56\text{ }\Omega$				$\mu\text{C}$
$t_{rr}$	$V_R = 65\text{ A}; di/dt = 100\text{ A}/\mu\text{s}$				ns
<b>Free-wheeling diode</b>					
$V_F$	$I_F = \text{A}; V_{GS} = \text{V}$				V
$I_{RRM}$	under following conditions:				A
$Q_{rr}$	$I_F = \text{A}; T_{vj} = \text{°C}$				$\mu\text{C}$
$t_{rr}$	$V_f = \text{A}; di/dt = \text{A}/\mu\text{s}$				ns
<b>Mechanical data</b>					
M1	mounting torque			2	Nm
w			20		g
Case	SEMITOP <sup>®</sup> 2		T 47		

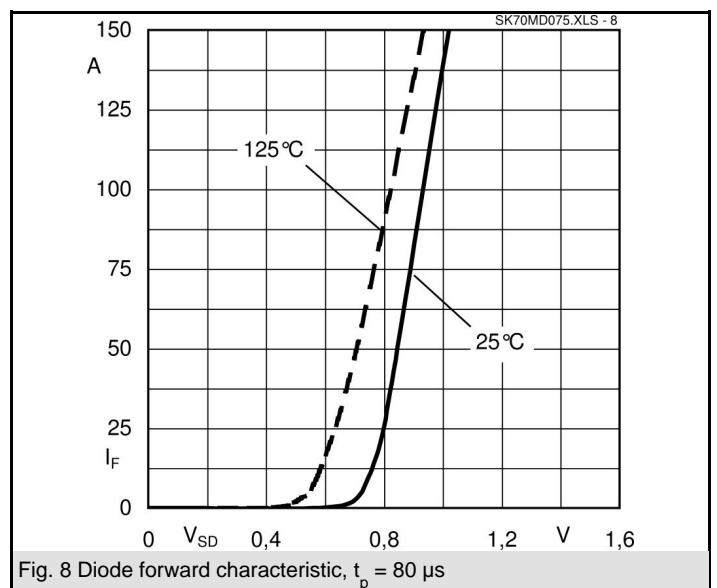
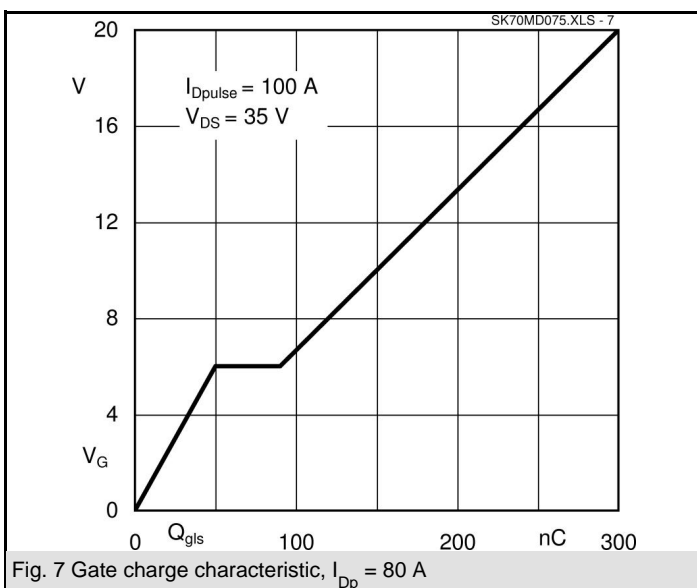
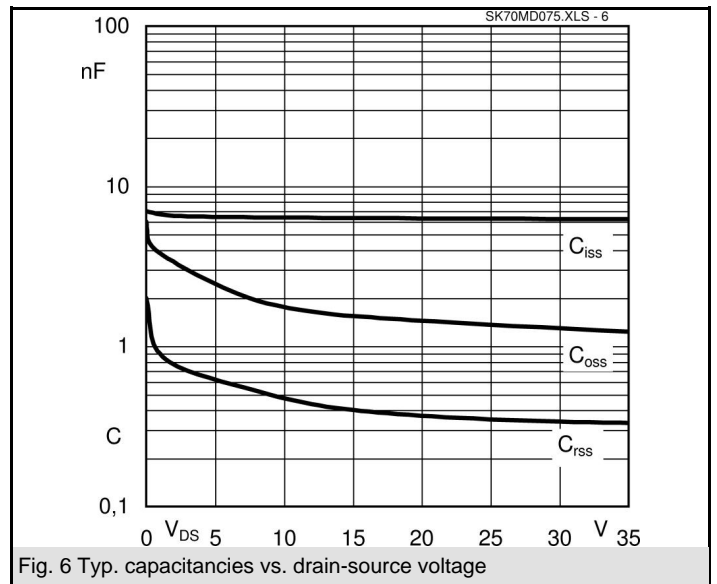
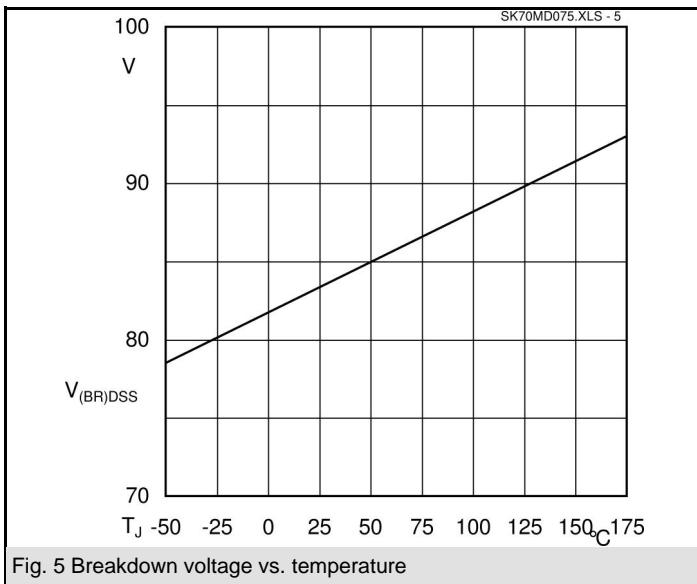
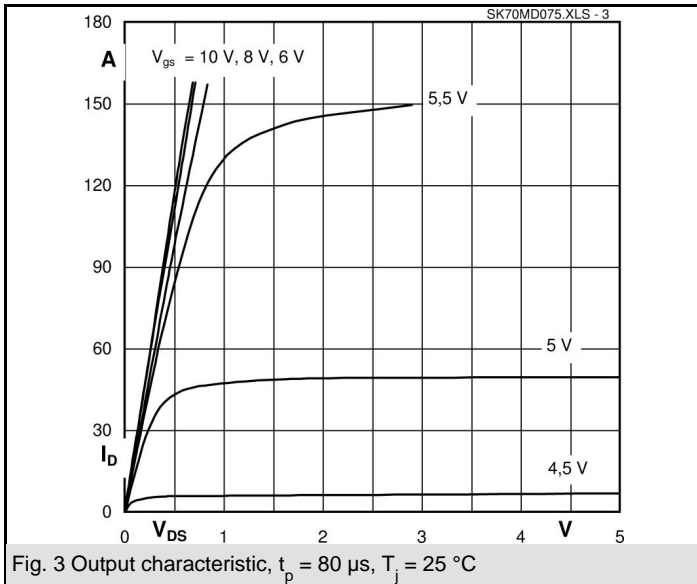

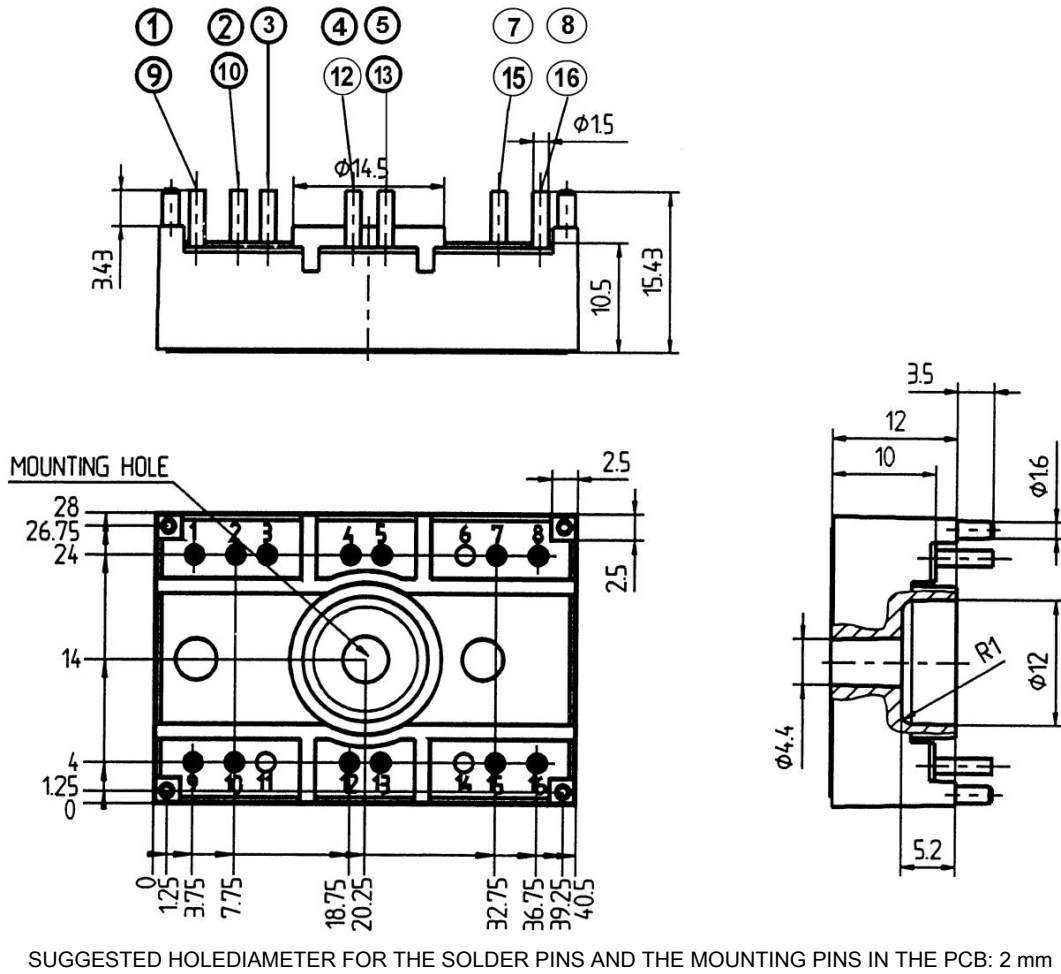

Case T 47

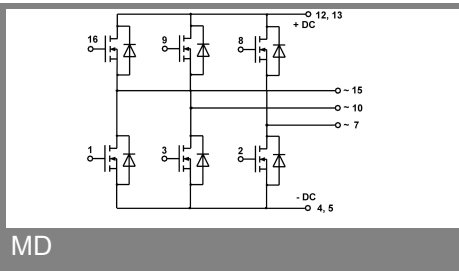

This is an electrostatic discharge sensitive device (ESDS), international standard IEC 60747-1, Chapter IX.

This technical information specifies semiconductor devices but promises no characteristics. No warranty or guarantee expressed or implied is made regarding delivery, performance or suitability.